

# KOIZA®

DIGITAL PRINTING • LCD.LED DISPLAYS

## DISPLAYS 01

Gama completa de displays portáteis que fornecem uma solução integral para a exposição em eventos promocionais, lojas ou apresentações de negócios.

- 6 X-BANNER
- 10 L-BANNER
- 12 ROLL UP | ECONOMIC
- 16 ROLL UP | STANDARD
- 20 ROLL UP | STYLISH
- 25 ROLL UP | DELUXE
- 31 ROLL UP | LARGE
- 35 ROLL UP ACCESSORIES
- 38 DESKTOP DISPLAYS
- 40 STAND DISPLAYS
- 49 REFILLABLE BASES
- 52 DISPLAY BASES
- 58 SIDEWALK BOARDS





# X-BANNER Display



## DISPLAY DETAILS

## GRAPHIC BY EYELETS



## DIMENSIONS

\*mm

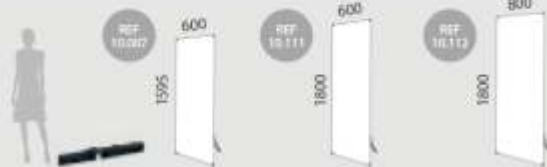

## INFORMATION

Tudela X-Banner is a portable, detachable and lightweight display for interchangeable graphics. Its X-shaped structure is made of fiberglass and plastic. The exhibitors can quickly assemble it in a few seconds (no tools required). Tudela features 3 sizes available and it includes a nylon carry bag.

BOOKING	QTY	N.W	G.W	C.B.M	SIZE
Packing	10	9kg	10kg	0.025	1010x200x250mm
Utl.	1	0.90kg	1kg	0.005	160x30x1050mm
<b>10.007</b>	Graphic Size: 600x1595mm				
BOOKING	QTY	N.W	G.W	C.B.M	SIZE
Packing	10	9.5kg	10.5kg	0.029	1210x200x250mm
Utl.	1	0.95kg	1.05kg	0.007	180x40x1210mm
<b>10.111</b>	Graphic Size: 600x1800mm				
BOOKING	QTY	N.W	G.W	C.B.M	SIZE
Packing	10	10kg	11kg	0.029	1210x200x250mm
Utl.	1	1kg	1.1kg	0.008	170x40x1710mm
<b>10.112</b>	Graphic Size: 800x1800mm				

## TUDELA



## DISPLAY DETAILS

## GRAPHIC BY EYELETS



## DIMENSIONS

\*mm

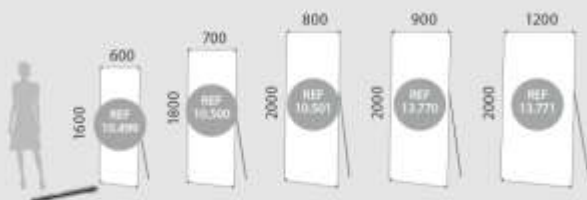

## INFORMATION

The Lyon X-Banner is a portable, detachable and very lightweight display for interchangeable graphics. Its X-shaped structure is made of fiberglass and plastic. Quickly assembly in-seconds (no tools required). It includes a nylon carry bag. Lyon features 5 sizes available.

800x2000	QTY	N.W	G.W	C.B.M	SIZE
Packing	90	16.5kg	17.5kg	0.1208	300x350x1000mm
Unit	1	0.30kg	0.33kg	0.001	140x60x200mm

**10.499** Graphic Size: 600x1600mm

700x1800	QTY	N.W	G.W	C.B.M	SIZE
Packing	90	20kg	22kg	0.1484	400x350x900mm
Unit	1	0.35kg	0.40kg	0.001	140x60x200mm

**10.500** Graphic Size: 700x1800mm

800x2000	QTY	N.W	G.W	C.B.M	SIZE
Packing	90	22.5kg	23.5kg	0.182	400x400x900mm
Unit	1	0.40kg	0.45kg	0.01	140x60x200mm

**10.501** Graphic Size: 800x2000mm

900x2000	QTY	N.W	G.W	C.B.M	SIZE
Packing	90	16.6kg	16.7kg	0.178	320x410x900mm
Unit	1	0.73kg	1kg	0.01	140x60x200mm

**13.770** Graphic Size: 900x2000mm

1200x2000	QTY	N.W	G.W	C.B.M	SIZE
Packing	90	22kg	23.2kg	0.180	320x500x900mm
Unit	1	1.1kg	1.3kg	0.01	140x60x200mm

**13.771** Graphic Size: 1200x2000mm

## LYON



get extra tension using the hook with a counterweight

# X-BANNER X-Banner

## DISPLAY DETAILS

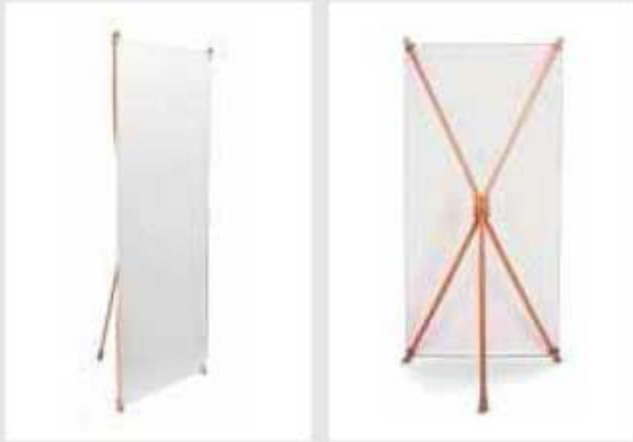

## DISPLAY DETAILS

## GRAPHIC ATTACHMENT BY EYELETS



## DIMENSIONS

\*mm

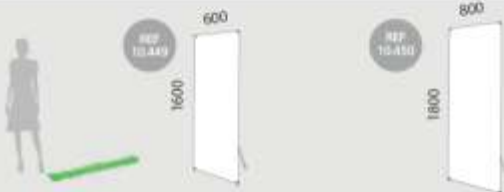

## INFORMATION

The Bamboo X-Banner is a portable, detachable and lightweight display for interchangeable graphics. It is made of Bamboo Wood. Exhibitors can quickly assemble it in a few seconds (no tools required). A green nylon carry bag is included. Ideal for getting a touch of stylish and functional design.

BAMBOO 800	QTY	B.W.	G.W.	C.B.M.	SIZE
Packing	40	20kg	22,50kg	0.13	450x270x130mm
Utr.	1	0,50kg	0,59kg	0,004	105x40x180mm
<b>10.449</b>	<b>Graphic Size: 600x1600mm</b>				

BAMBOO 800	QTY	B.W.	G.W.	C.B.M.	SIZE
Packing	40	34kg	36kg	0.15	280x150x180mm
Utr.	1	0,85kg	0,90kg	0,005	105x40x170mm
<b>10.450</b>	<b>Graphic Size: 800x1800mm</b>				

## BAMBOO





# L-BANNER Display



## MESTANZA

### DISPLAY DETAILS



### INFORMATION

\*mm

Mestanza L-Banner is a detachable and lightweight display for interchangeable graphics. Its stable L-shaped structure is easy to set-up. Exhibitors can quickly assemble it with 3 simple steps. Includes a carry bag.

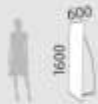

MESTANZA	QTY	N.W.	G.W.	CBM	SIZE
Packing	25	70kg	0.23kg	0.075	300x230x1000mm
Unit	1	0.40kg	0.43kg	0.004	160x30x1600mm
10.774		Graphic Size: 600x1600mm			



### DISPLAY DETAILS



### INFORMATION

\*mm

Navas is a portable, detachable and lightweight display for interchangeable graphics. Its stable L-shape can quickly assemble in a few seconds (graphic is attached by adhesive). Includes a carry bag.



NAVAS	QTY	N.W.	G.W.	CBM	SIZE
Packing	20	14kg	0.20kg	0.081	340x240x1000mm
Unit	1	0.70kg	1kg	0.032	1100x10x930mm
10.001		Graphic Size: 600x1840mm			

## NAVAS





**INFORMATION** \*mm

Bonne L-Banner is a detachable and lightweight display for interchangeable graphics. It is made of aluminium and plastic. Its stable L-shaped structure (with 490mm depth) is very easy to set-up, so exhibitors can quickly assemble in only a few seconds (the graphic is attached by upper snap rail). Also, Bonn L-Banner includes a black nylon carry bag for a better transportation.



BONN	QTY	N.W	G.W	C.B.M	SIZE
Packing	10	7kg	12kg	0.048	800x200x300mm
Unit	1	1.0kg	1.20kg	0.023	200x225x90mm
10.575	Graphic Size: 800x1800mm				





# ROLL-UP Display



## DISPLAY DETAILS



## DIMENSIONS

\*mm

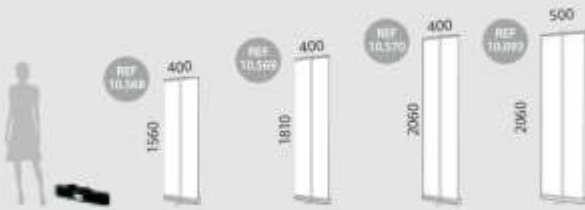

## INFORMATION

Abadia Roll Up is a portable and lightweight display for interchangeable and retractable graphics. It is made of aluminium and plastic parts. Banner rolls up and down in seconds making setting up presentation quick and easy. It includes a carry bag for effortless transport. Abadia is ideal to display in front of columns.

ABADIA1	QTY	N.W	G.W	C.B.M	SIZE
Packing	10	3,5kg	8kg	0,04	450x230x470mm
Utl.	1	0,75kg	0,80kg	0,001	95x95x430mm
<b>10.568</b>	<b>Graphic Size: 400x1560mm</b>				
ABADIA2	QTY	N.W	G.W	C.B.M	SIZE
Packing	10	3,5kg	8kg	0,04	450x230x470mm
Utl.	1	0,75kg	0,80kg	0,001	95x95x430mm
<b>10.569</b>	<b>Graphic Size: 400x1810mm</b>				
ABADIA3	QTY	N.W	G.W	C.B.M	SIZE
Packing	10	3,5kg	8kg	0,04	450x230x470mm
Utl.	1	0,75kg	0,80kg	0,001	95x95x430mm
<b>10.570</b>	<b>Graphic Size: 400x2060mm</b>				
ABADIA4	QTY	N.W	G.W	C.B.M	SIZE
Packing	10	1kg	17kg	0,05	485x230x600mm
Utl.	1	1,5kg	1,7kg	0,004	95x95x550mm
<b>10.093</b>	<b>Graphic Size: 500x2060mm</b>				

## ABADIA



# ROLL UP BANNER Economic Roll Up

**new**

## TORINO



### DISPLAY DETAILS



### DIMENSIONS



### INFORMATION

Torino features a kit of accessories (sold separately) which allow you to join together with another Torino and get a 2-sided view. Set up is easy, just line up the 2 Units, connect the bases, raise the banners and connect them at top. Carry bag included.

600x2060	QTY	N.W	G.W	C.B.M	SIZE
Packing	10	0.7kg	1.9kg	0.04	430x170x155mm
Unit	1	1.27kg	1.39kg	0.005	30x80x625mm
<b>13.827-600</b>	<b>Graphic Size: 600x2060mm</b>				
800x2060	QTY	N.W	G.W	C.B.M	SIZE
Packing	10	1kg	1.9kg	0.06	430x170x190mm
Unit	1	1.7kg	1.8kg	0.006	90x90x825mm
<b>13.827-800</b>	<b>Graphic Size: 800x2060mm</b>				
850x2060	QTY	N.W	G.W	C.B.M	SIZE
Packing	10	1.9kg	2.9kg	0.06	430x170x190mm
Unit	1	1.9kg	2.9kg	0.007	90x90x875mm
<b>13.827-850</b>	<b>Graphic Size: 850x2060mm</b>				
1000x2060	QTY	N.W	G.W	C.B.M	SIZE
Packing	10	2kg	2.9kg	0.07	430x170x190mm
Unit	1	2.3kg	2.3kg	0.006	90x90x1025mm
<b>13.827-1000</b>	<b>Graphic Size: 1000x2060mm</b>				
1200x2060	QTY	N.W	G.W	C.B.M	SIZE
Packing	10	2.9kg	2.9kg	0.09	430x170x230mm
Unit	1	2.5kg	2.4kg	0.009	90x90x1225mm
<b>13.827-1200</b>	<b>Graphic Size: 1200x2060mm</b>				

### DOUBLE-SIDED ACCESSORIES KIT



ACCESSORY	QTY	N.W	G.W	C.B.M	SIZE
Packing	10	4.5kg	5kg	0.07	400x220x180mm
Unit	1	0.41kg	0.47kg	0.0057	250x50x150mm
<b>13.828</b>	<b>Double Side Accessories Kit</b>				





# ROLL UP BANNER Economic Roll Up

## SIDNEY

### DISPLAY DETAILS



### DIMENSIONS

\*mm



### INFORMATION

The Sidney Roll Up is a quick yet economical solution for your business presentation needs. It features metal connections at base feet and also, an improved stability thanks its special joining pole piece. It is made of anodized aluminium and plastic parts. Also it includes a hand strap carry bag.

SIDNEY 850	QTY	N.W	G.W	C.B.M	SIZE
Packing	6	10.8kg	32kg	0.03	100x200x850mm
Unit	1	1.8kg	2kg	0.007	80x90x175mm
<b>13.709</b>		<b>Graphic Size: 850x2060mm</b>			

SIDNEY 1000	QTY	N.W	G.W	C.B.M	SIZE
Packing	6	11.8kg	35kg	0.063	100x200x1050mm
Unit	1	2.3kg	2.5kg	0.008	80x98x1040mm
<b>13.710</b>		<b>Graphic Size: 1000x2060mm</b>			



“  
The Roll Up design saves floor space  
”

# ROLL UP BANNER Economic Roll Up

## ALCALA

### DISPLAY DETAILS



### DIMENSIONS

\*mm



### INFORMATION

Alcala-Roll Ups features 5 widths available. It is made of aluminium and plastic parts. Banner rolls up and down in seconds making setting up presentation quick and easy. Also it includes a single oxford carry bag.

800x2060	QTY	N.W	G.W	C.B.M	SIZE
Packing	6	11.5kg	12kg	0.05	300x210x800mm
Unit	1	1.91kg	2kg	0.006	90x90x480mm
<b>10.401</b>		<b>Graphic Size: 800x2060mm</b>			
850x2060	QTY	N.W	G.W	C.B.M	SIZE
Packing	6	12.5kg	13kg	0.06	300x210x900mm
Unit	1	2.08kg	2.3kg	0.007	90x90x475mm
<b>10.801</b>		<b>Graphic Size: 850x2060mm</b>			
1000x2060	QTY	N.W	G.W	C.B.M	SIZE
Packing	6	14.5kg	15kg	0.07	300x210x950mm
Unit	1	2.4kg	2.5kg	0.008	90x90x480mm
<b>10.510</b>		<b>Graphic Size: 1000x2060mm</b>			
1250x2060	QTY	N.W	G.W	C.B.M	SIZE
Packing	6	18.5kg	19kg	0.08	300x210x1000mm
Unit	1	3.08kg	3.3kg	0.012	96x95x270mm
<b>10.511</b>		<b>Graphic Size: 1250x2060mm</b>			
1500x2060	QTY	N.W	G.W	C.B.M	SIZE
Packing	6	20.5kg	21kg	0.10	300x210x1050mm
Unit	1	3.4kg	3.5kg	0.016	100x95x150mm
<b>10.512</b>		<b>Graphic Size: 1500x2060mm</b>			



“ Use optional spotlight for highlight your exhibitions (sold separately) ”

# ROLL UP BANNER Standard Roll Up

**new**

## ORLEANS

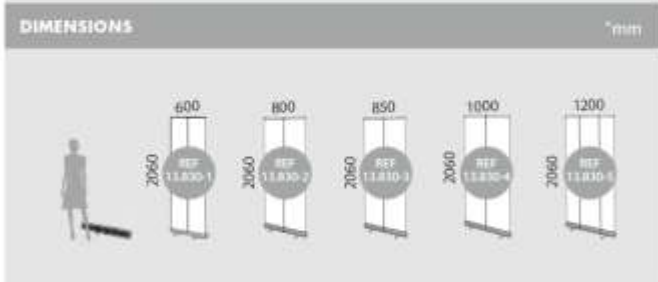

600x2060	QTY	N.W	G.W	C.B.M	SIZE
Packing	6	16.2kg	16.6kg	0.05	300x240x70mm
Unit	1	2.70kg	2.77kg	0.009	700x110x95mm
<b>13.830-600</b>	Graphic Size: 600x2060mm				

800x2060	QTY	N.W	G.W	C.B.M	SIZE
Packing	6	19.9kg	20kg	0.07	300x240x70mm
Unit	1	3.2kg	3.33kg	0.02	700x150x95mm
<b>13.830-800</b>	Graphic Size: 800x2060mm				

850x2060	QTY	N.W	G.W	C.B.M	SIZE
Packing	6	20.4kg	21kg	0.07	300x240x70mm
Unit	1	3.4kg	3.5kg	0.02	700x110x90mm
<b>13.830-850</b>	Graphic Size: 850x2060mm				

1000x2060	QTY	N.W	G.W	C.B.M	SIZE
Packing	6	25.3kg	22.2kg	0.08	350x240x70mm
Unit	1	3.55kg	3.7kg	0.014	700x150x95mm
<b>13.830-1000</b>	Graphic Size: 1000x2060mm				

1200x2060	QTY	N.W	G.W	C.B.M	SIZE
Packing	6	27.6kg	29.6kg	0.10	350x240x70mm
Unit	1	4.6kg	4.9kg	0.017	700x170x250mm
<b>13.830-1200</b>	Graphic Size: 1200x2060mm				



# ROLL UP BANNER Standard Roll Up

**new**

## ORLEANS



**INFORMATION**

Orleans is one of the best-selling Roll-Ups in the world. Featuring an extra weight aluminium structure with 10 sizes available. Banner rolls up and down in seconds making setting up presentation quick and easy. It includes a carry bag.



000x2060	QTY	N.W	G.W	C.B.M	SIZE
Packing	4	22kg	25.4kg	0.08	250x250x990mm
Unit	1	5.5kg	6.3kg	0.02	120x120x160mm

**13.830-1500** Graphic Size: 1500x2060mm

050x2060	QTY	N.W	G.W	C.B.M	SIZE
Packing	2	11.8kg	12.3kg	0.05	100x250x830mm
Unit	1	5.9kg	6.1kg	0.02	120x120x180mm

**13.830-1750** Graphic Size: 1750x2060mm

1000x2060	QTY	N.W	G.W	C.B.M	SIZE
Packing	2	13kg	14kg	0.06	130x250x200mm
Unit	1	6.5kg	7kg	0.03	120x120x200mm

**13.830-2000** Graphic Size: 2000x2060mm

1200x2060	QTY	N.W	G.W	C.B.M	SIZE
Packing	2	14.6kg	15.8kg	0.07	130x250x220mm
Unit	1	7.3kg	7.9kg	0.03	120x120x220mm

**13.830-2200** Graphic Size: 2200x2060mm

1400x2060	QTY	N.W	G.W	C.B.M	SIZE
Unit	1	8.2kg	8.9kg	0.04	100x150x240mm

**13.830-2400** Graphic Size: 2400x2060mm



Use promotional counters for completing your exhibitions (sold separately)

# ROLL UP BANNER Standard Roll Up

## DISPLAY DETAILS



## DIMENSIONS

\*mm

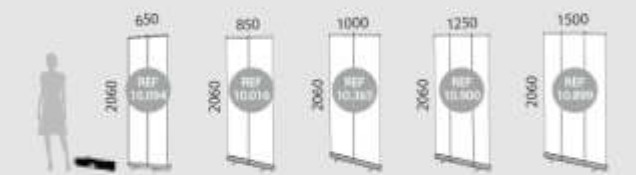

## INFORMATION

The Alberca Roll Up features an extra weight aluminium structure with 5 widths available. Banner rolls up and down in seconds making setting up presentation quick and easy. Also it includes a double padded carry bag.

650x2060	QTY	N.W	G.W	C.B.M	SIZE
Packing	10	18kg	18kg	0.06	100x200x490mm
Unit	1	1.8kg	1.8kg	0.005	95x5x650mm

**10.094** Graphic Size: 650x2060mm

850x2060	QTY	N.W	G.W	C.B.M	SIZE
Packing	6	17.5kg	18kg	0.07	120x230x900mm
Unit	1	2.9kg	3kg	0.009	100x30x890mm

**10.016** Graphic Size: 850x2060mm

1000x2060	QTY	N.W	G.W	C.B.M	SIZE
Packing	6	19.5kg	20kg	0.08	120x230x950mm
Unit	1	3.5kg	3.3kg	0.01	100x100x940mm

**10.365** Graphic Size: 1000x2060mm

1250x2060	QTY	N.W	G.W	C.B.M	SIZE
Packing	8	21.5kg	22kg	0.10	120x230x1000mm
Unit	1	3.5kg	3.0kg	0.02	100x100x1000mm

**10.900** Graphic Size: 1250x2060mm

1500x2060	QTY	N.W	G.W	C.B.M	SIZE
Packing	6	23kg	24kg	0.1	120x230x1050mm
Unit	1	3.8kg	4kg	0.05	100x100x1040mm

**10.899** Graphic Size: 1500x2060mm

## ALBERCA



“ Get stability and extra weight thanks its higher aluminium thickness ”

# ROLL UP BANNER Standard Roll Up

## MORA

### DISPLAY DETAILS



### DIMENSIONS

\*mm



### INFORMATION

Mora is a Double Sided Roll Up wich features 2 widths available (850mm or 1000mm). It is made of aluminium and plastic parts. Banner rolls up and down in seconds making setting up presentation quick and easy. Mora features a stable base with no-feet design with leveling feet. Also it includes a carry bag. Ideal for trade shows, expositions, retail stores or any media event.

MORA 850	QTY	N.W	G.W	C.B.M	SIZE
Packing	4	15.6kg	18.8kg	0.02727	850x150x130mm
Unit	1	3.90kg	4.70kg	0.007	850x150x130mm
13.725	Graphic Size: 850x2060mm				
MORA 1000	QTY	N.W	G.W	C.B.M	SIZE
Packing	4	17.6kg	21kg	0.03850	1040x150x130mm
Unit	1	4.40kg	5.25kg	0.009	1040x150x130mm
13.726	Graphic Size: 1000x2060mm				



# ROLL UP BANNER Stylish Roll Up

## DISPLAY DETAILS



## DIMENSIONS

\*mm



## INFORMATION

This Roll Up features a full black finish and it is made of durably aluminum so it is incredibly lightweight and saves floor space. Easy change of graphic, set up is quick and easy, just connect the pole to the base, roll-up the graphic and hook it at the top of the pole. With canvas carry bag included. Ideal for trade shows, expositions, retail stores or any media event.

ALTEA 850	QTY	N.W	G.W	CBM	UUT
Packing	10	22kg	34kg	0.091	490x210x910mm
Utl.	1	2.20kg	3.40kg	0.007	90x80x75mm

10.680 Graphic Size: 850x2060mm

ALTEA 1000	QTY	N.W	G.W	CBM	UUT
Packing	10	25kg	36kg	0.109	490x210x960mm
Utl.	1	2.50kg	3.60kg	0.011	105x85x80mm

10.681 Graphic Size: 1000x2060mm

## ALTEA



Use optional spotlight to highlight your exhibitions (sold separately)

\* optional spotlight (sold apart, see how Roll Up accessories at Cap. 12)

# ROLL UP BANNER Stylish Roll Up

## DUERO

### DISPLAY DETAILS



### DIMENSIONS

\*mm



### INFORMATION

This Roll Up banner is made of durably aluminum with plastic parts so it is incredibly lightweight and slim-line design that makes it visually appealing and saves floor space. Easy change of graphic, set up is quick and easy, users can simply connect the pole to the base, roll-up the graphic and hook the banner at the top of the pole. Additionally, a canvas carry bag is included. Ideal for trade shows, expositions, retail stores or any media event.

DUERO1880	QTY	N.W	G.W	C.B.M	SIZE
Packing	6	14.4kg	14.8kg	0.078	220x270x910mm
Unit	1	2.4kg	2.8kg	0.01	70x105x290mm
<b>13.578</b>	Graphic Size: 850x2060mm				

DUERO1000	QTY	N.W	G.W	C.B.M	SIZE
Packing	6	35.8kg	37.4kg	0.092	220x270x1060mm
Unit	1	5.9kg	6.2kg	0.015	105x105x340mm
<b>13.579</b>	Graphic Size: 1000x2060mm				





# ROLL UP BANNER Stylish Roll Up

## DISPLAY DETAILS



## DIMENSIONS

\*mm

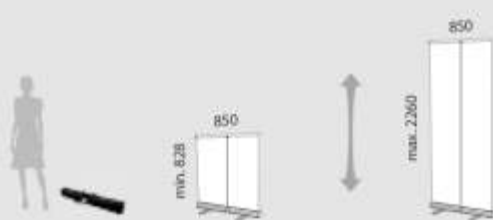

## INFORMATION

This Roll Up banner is made of durably aluminum with plastic parts so it is incredibly lightweight and saves floor space. Featuring stylish open bases and adjustable height thanks to its telescopic pole. With an easy change of graphic, set up is quick and easy. Additionally, a canvas carry bag is included. Ideal for trade shows, expositions, retail stores or any media event.

DEHESA	QTY	NW	GW	CBM	WE
Packing	6	19,20kg	23kg	0,09	390x260x910mm
Utl.	1	3,2kg	3,50kg	0,08	10x110x900mm
10,020		Graphic Size: 850x828-2260mm			

## DEHESA



“ Use promotional counters for completing your exhibitions (sold separately) ”

# ROLL UP BANNER Stylish Roll Up

**new**

## MILANO



### GRAPHIC CASSETTE EXCHANGE      DIMENSIONS \*mm



### INFORMATION

Milano Roll Up is made of durably aluminum with plastic parts. It features an easy change of graphic thanks its unique design with a interchangeable cassette, graphic change is quick and easy, users can simply put the cassette into the base, roll-up the graphic and hook the banner at the top of the pole. Additionally, a canvas carry bag is included. Ideal for trade shows, expositions, retail stores or any media event.

MILANO 850	QTY	NO	CO	C.B.M	SIZE
Packing	4	18kg	17kg	0.07	300x290x1025mm
Unit	1	4kg	4.25kg	0.02	150x100x1025mm

13.829-850      Graphic Size: 850x1640-2260mm

MILANO 1000	QTY	NO	CO	C.B.M	SIZE
Packing	4	18kg	18kg	0.08	300x290x1000mm
Unit	1	4.5kg	4.75kg	0.02	150x100x1025mm

13.829-1000      Graphic Size: 1000x1640-2260mm



“ With an comfortable and fast change of graphic thanks its interchangeable cassette. ”

# ROLL UP BANNER Stylish Roll Up

## BAMBOO

### DISPLAY DETAILS



### DISPLAY DETAILS



bamboo wood



### INFORMATION

This Roll Up is made of bamboo wood. Featuring stylish natural design. With an easy change of graphic, set up is quick and easy. A nylon carry bag is included. Ideal for trade shows, expositions, retail stores or any event.



BAMBOO	QTY	L.W	G.W	C.B.M	SET
Packing	4	12.6kg	15.2kg	0.091	350x290x900mm
Unit	1	1.8kg	3.80kg	0.02	170x140x870mm
10.444	Graphic Size: 800x2060mm				



# ROLL UP BANNER Deluxe Roll Up



## CERVERA

**DISPLAY DETAILS**



**INFORMATION**

Cervera Luxury Roll Up features silver or black finish available. The aluminum design is durable, yet attractive and adds a stylish and luxurious touch. Cervera base has leveling feet and also, it includes a double padded carry bag.

**DIMENSIONS** \*mm



CERVERA 850	QTY	N.W	G.W	C.B.M	SIZE
Packing	4	17.4kg	20.6kg	0.081	890x700x430mm
Uw.	1	4.35kg	5.15kg	0.018	180x135x20mm
<b>10.015</b>		<b>Graphic Size: 850x2060mm</b>			

CERVERA 1000	QTY	N.W	G.W	C.B.M	SIZE
Packing	4	21.8kg	23.2kg	0.097	850x1000x1180mm
Uw.	1	5.4kg	5.8kg	0.0216	180x135x20mm
<b>13.707</b>		<b>Graphic Size: 1000x2060mm</b>			

CERVERA 850	QTY	N.W	G.W	C.B.M	SIZE
Packing	4	17.6kg	20kg	0.083	890x700x430mm
Uw.	1	4.4kg	5.25kg	0.018	180x135x20mm
<b>10.955</b>		<b>Graphic Size: 850x2060mm</b>			



“ Ideal for providing a distinguishing and stylish touch. ”

# ROLL UP BANNER Deluxe Roll Up

## RIBAS

### DISPLAY DETAILS



### INFORMATION

\*mm

Ribas Roll Up features silver finish available. Its unique design is durable, yet attractive and adds a stylish and luxurious touch. Its base has leveling feet and also it is double-sided so it can be used as a sidewalk stand (ideal for areas with 2-ways traffic). It includes a double padded carry bag.



RIBAS	QTY	NW	GW	CBM	SIZE
Packing	4	22kg	26.5kg	0.16	530x300x900mm
Dim	1	5.5kg	5.6kg	0.03	250x135x920mm
10.013	Graphic Size: 850x2060mm				



# ROLL UP BANNER Deluxe Roll Up

## IBIZA

### DISPLAY DETAILS



### FLEX SYSTEM

\*mm

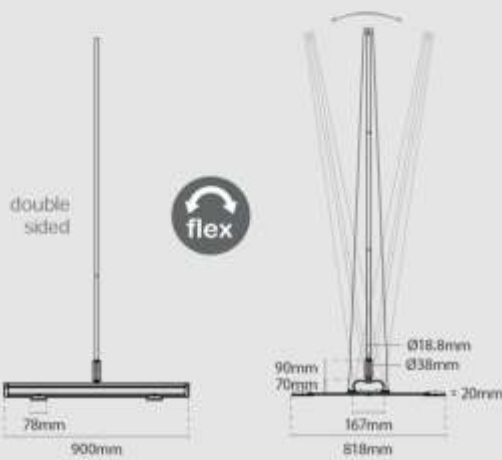

### INFORMATION

\*mm

This Roll Up features a silver aluminium finish. Ibiza is suitable for being used at outdoor or indoor and its design features a flex system for resisting windy conditions. Its base is holed for being used with 4 stakes (included). Also, it is 2-sided so it can be used as a sidewalk stand (ideal for areas with 2-ways traffic). It includes a double padded carry bag.



IBIZA	QTY	NW	GW	CBM	SIZE
Packing	1	7.6kg	8.8kg	0.03	390x390x930mm
10.447		Graphic Size: 850x2060mm			



# ROLL UP BANNER Deluxe Roll Up

## PINEDA SCROLL

### DISPLAY DETAILS



### INFORMATION

\*mm

Pineda Roll Up features an electrical scrolling design which allows to display a large 4105mm and continuous graphic banner. Its base has leveling feet and it includes a double padded carry bag. Pineda Scroll Roll Up is ideal for being used at conventions, tradeshows, expositions, business presentations or at any media event.



PINEDA	QTY	N.W	G.W	C.M	SIZE
Packing	4	18.90kg	24.60kg	0.16	530x300x980mm
Unit	1	4.95kg	8.15kg	0.04	280x110x675mm

10.022    Graphic: 780x4105mm    Visible: 780x2060mm



# ROLL UP BANNER Deluxe Roll Up

## BREMEN

### DISPLAY DETAILS



### INFORMATION

\*mm

The Bremen Roll Up has a silver aluminium finish and it features a middle shelf for the displaying of promotional items or appetizers at tradeshows or conventions. Also, it has 2x A4 format trays for brochures or literature. It includes a double padded nylon carry bag.

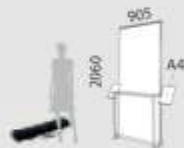

BREMEN	QTY	N.W	G.W	C.M	SIZE
--------	-----	-----	-----	-----	------

Packing	1	6.30kg	6.98kg	0.037	250x150x990mm
---------	---	--------	--------	-------	---------------

10.826	Graphic Size: 905x2060mm				
--------	--------------------------	--	--	--	--





# ROLL UP BANNER Deluxe Roll Up

## DISPLAY DETAILS



## INFORMATION

\*mm

This Roll Up features a tablet holder (2 sizes available) whose frame allows a 360° rotation. Also, it has lock for safety use. It includes a double padded carry bag. Pineda Scroll Roll Up is ideal for conventions, tradeshows, expositions, media events or any business presentation.

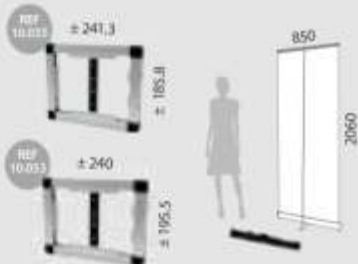

TABLET HOLDER 1	QTY	N.W	G.W	C.B.M	SIZE
Packing	1	0.75kg	0.90kg	0.003	250x17x310mm
		3.80kg	4.10kg	0.005	190x10x910mm
10.035	Roll Up Graphic Size: 850x2060mm Size for Tablets: ±185.8x241.3mm				
TABLET HOLDER 2	QTY	N.W	G.W	C.B.M	SIZE
Packing	1	0.75kg	0.90kg	0.003	250x17x310mm
		3.80kg	4.10kg	0.005	190x10x910mm
10.053	Roll Up Graphic Size: 850x2060mm Size for Tablets: ±195.5x240mm				

## TABLET HOLDER ROLL UP



\*table is not included

# ROLL UP BANNER LARGE RECYCLE ♿ ✕ 🗑️ Large Roll Up



## DIMENSIONS \*mm



## INFORMATION

The Nepal Roll Up banner is made of durably aluminum with plastic parts and features an adjustable height up to 3m. Set up is quick and easy and users can adjust the height tilting lowering the Roll Up Banner. A Nylon Carry bag is included. Ideal for trade shows, convention centers, malls, expositions, retail stores or any media event where their large graphics can be seen from at the distance. There are 4 widths available.

NEPAL 850	QTY	N.W	G.W	C.B.M	SIZE
Packing	6	24kg	25kg	0.088	380x280x920mm
Unit	1	4kg	4.2kg	0.015	125x100x855mm
<b>13.583</b>	Graphic Size: 850x1850-3060mm				
NEPAL 1000	QTY	N.W	G.W	C.B.M	SIZE
Packing	6	28.2kg	29kg	0.138	380x280x1070mm
Unit	1	4.7kg	4.83kg	0.027	125x100x1030mm
<b>13.584</b>	Graphic Size: 1000x1850-3060mm				
NEPAL 1500	QTY	N.W	G.W	C.B.M	SIZE
Packing	2	13.8kg	15kg	0.064	270x50x1580mm
Unit	1	6.9kg	7.5kg	0.025	125x100x855mm
<b>13.585</b>	Graphic Size: 1500x1850-3060mm				
NEPAL 2000	QTY	N.W	G.W	C.B.M	SIZE
Unit	1	9.5kg	10kg	0.0468	150x150x2380mm
<b>13.586</b>	Graphic Size: 2000x1850-3060mm				

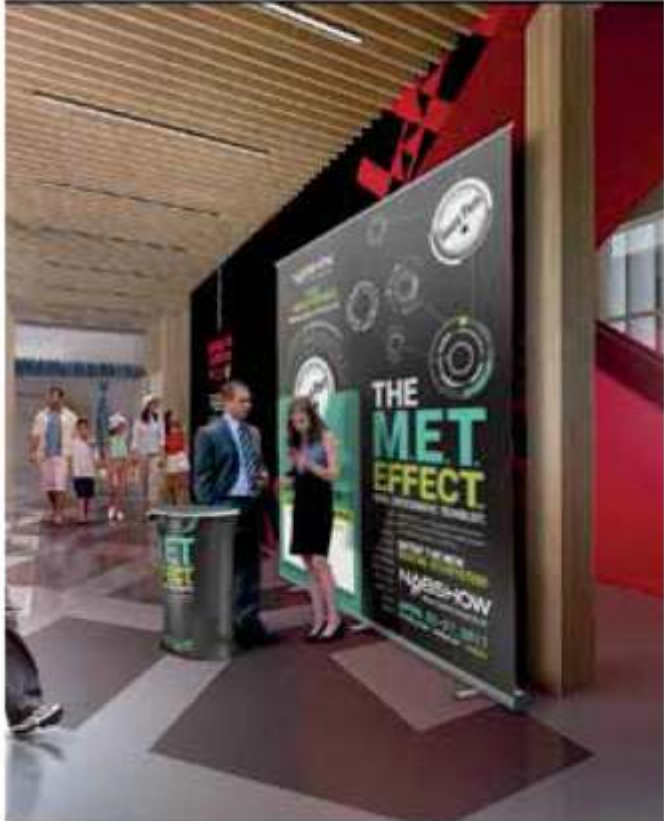

# ROLL UP BANNER LARGE RECYCLE NO WASTE ? Large Roll Up



**INFORMATION** **DIMENSIONS** <sup>mm</sup>

The Everest Roll Up banner is made of durable aluminum with magnetic side connection parts, featuring 3m height. At the top of each banner stand, there are patented magnetic connectors that allow you to join together multiple units with a simple "click". Because of its size, it is a great alternative to pop-up displays and trade show booths. Set up is quick and easy, and users can adjust the height tilting lowering the Roll Up Banner. Additionally, a canvas carry bag is included. This Roll Up makes a great graphic mural in trade show booths, in press conferences, convention centers, in malls, expositions, retail stores or any other media event.



EVEREST	QTY	NW	GW	CBM	SIZE
Packing	6	40.2kg	49kg	0.35	420x290x260mm
Unit	1	6.50kg	7.70kg	0.06	120x120x260mm
10.861		Graphic Size: 1200x3060mm			



# ROLL UP BANNER Large Roll Up

## DISPLAY DETAILS



## DIMENSIONS

mm



## INFORMATION

If you are looking for something bigger, the Mont Blanc Roll Up Banner is 2000mm wide, featuring an adjustable height up to 3060mm. It is the perfect alternate to a trade show booth or pop up display. Due to its large height, assembly is easiest when you set up along the floor and then stand the display up. Also thanks to its telescopic capacity, the roll up Mont Blanc can be used in any other smaller places, with a minimum height of 1700mm. It comes with a carrying bag. It is perfect for trade shows, convention centers, for press conferences, expositions or for media events.

MONT BLANC	QTY	N.W	G.W	C.B.M	SIZE
Packing	1	11kg	14.80kg	0.061	180x180x200mm
10.441		Graphic Size: 2000x1700-3060mm			

## MONT BLANC

**XL**



# ROLL UP BANNER Large Roll Up

## DISPLAY DETAILS



## INFORMATION

Max Elda is the widest Roll Up, made of sturdy aluminium features 2 different widths, 2400 and 3200mm. Silver and black finish is available. Additionally, it includes a canvas carry nylon bag.



## DIMENSIONS

\*mm

2400 SILVER	QTY	N.W	G.W	C.B.M	SIZE
Packing	2	21.2kg	26.6kg	0.989	320x230x2580mm
Unit	1	10.6kg	13.3kg	0.071	320x90x2480mm
<b>10.936</b>	Graphic Size: 2400x2060mm				
3200 SILVER	QTY	N.W	G.W	C.B.M	SIZE
Packing	2	23kg	30.9kg	0.253	320x230x440mm
Unit	1	11kg	15.05kg	0.096	320x90x2340mm
<b>10.937</b>	Graphic Size: 3200x2060mm				
2400 BLACK	QTY	N.W	G.W	C.B.M	SIZE
Packing	2	21.2kg	26.6kg	0.989	320x230x2580mm
Unit	1	10.6kg	13.3kg	0.071	320x90x2480mm
<b>10.667</b>	Graphic Size: 2400x2060mm				
3200 BLACK	QTY	N.W	G.W	C.B.M	SIZE
Packing	2	23kg	30.9kg	0.253	320x230x440mm
Unit	1	11kg	15.05kg	0.096	320x90x2340mm
<b>10.668</b>	Graphic Size: 3200x2060mm				

## MAX ELDA



\* optional counter | sold apart, see table in [specs chapter]

# ROLL UP ACCESSORIES Bags

## BAG DETAILS



## INFORMATION

- One side zipped. With Id Pocket.
- Shoulder and hand strap.



850 | 1000 | 1250 | 1500

SINGLE 850	QTY	N.W	G.W	C.B.M	SIZE
Packing	1	0.0kg	0.22kg	0.0035	100x30x850mm
<b>13.461</b>					<b>For Roll Up 850mm</b>
SINGLE 1000	QTY	N.W	G.W	C.B.M	SIZE
Packing	1	0.0kg	0.25kg	0.0037	100x30x1000mm
<b>13.462</b>					<b>For Roll Up 1000mm</b>
SINGLE 1250	QTY	N.W	G.W	C.B.M	SIZE
Packing	1	0.17kg	0.30kg	0.0046	100x30x1250mm
<b>13.433</b>					<b>For Roll Up 1250mm</b>
SINGLE 1500	QTY	N.W	G.W	C.B.M	SIZE
Packing	1	0.50kg	0.70kg	0.0074	100x40x1500mm
<b>13.778</b>					<b>For Roll Up 1500mm</b>



## SINGLE OXFORD BAG

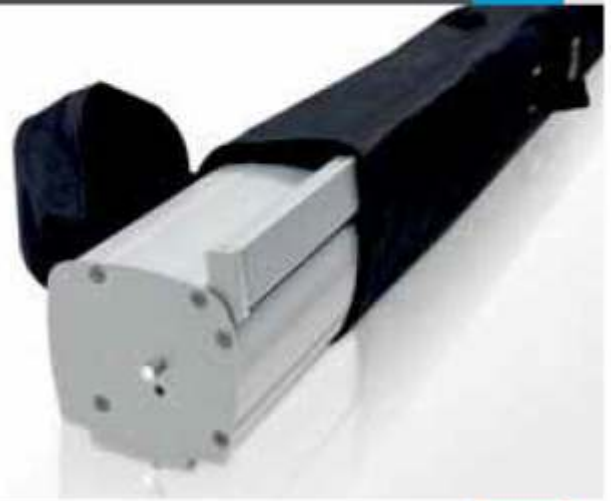

## BAG DETAILS



## INFORMATION

- Zipper on one side. With ID Pocket.
- Shoulder and hand strap. Double padded.



500 | 650 | 850 | 1000

DOUBLE 500	QTY	N.W	G.W	C.B.M	SIZE
Packing	1	0.20kg	0.40kg	0.0038	100x40x500mm
<b>13.494</b>					<b>For Roll Up 500mm</b>
DOUBLE 650	QTY	N.W	G.W	C.B.M	SIZE
Packing	1	0.28kg	0.30kg	0.0039	120x40x650mm
<b>13.495</b>					<b>For Roll Up 650mm</b>
DOUBLE 850	QTY	N.W	G.W	C.B.M	SIZE
Packing	1	0.40kg	0.60kg	0.0047	100x40x850mm
<b>13.463</b>					<b>For Roll Up 850mm</b>
DOUBLE 1000	QTY	N.W	G.W	C.B.M	SIZE
Packing	1	0.50kg	0.70kg	0.0049	120x40x1000mm
<b>13.464</b>					<b>For Roll Up 1000mm</b>

## DOUBLE PADDED BAG



## BAG DETAILS



## INFORMATION

- All crossed zipped.
- Shoulder and hand strap.
- With transparent pocket for ID Tag.



850 | 1000

ZIPPERED 850	QTY	N.W	G.W	C.B.M	SIZE
Packing	1	0.40kg	0.60kg	0.004	100x40x850mm
<b>13.459</b>					<b>For Roll Up 850mm</b>
ZIPPERED 1000	QTY	N.W	G.W	C.B.M	SIZE
Packing	1	0.50kg	0.70kg	0.004	120x40x1000mm
<b>13.460</b>					<b>For Roll Up 1000mm</b>

## DOUBLE PADDED ZIPPED BAG



“ Get an optimal protection for your Roll Up ”

\* Roll Up not included / Roll Up not visible / Roll Up not included / Roll Up not included

**SPOTLIGHT DETAILS**



**INFORMATION** \*mm

Spotlights for Roll Up with Plug-in base at top the pole. Bulb type Halogen (included) and directional head, large luminous capacity. Spotlight works directly plugged in. Black or matt aluminium finish.



PLUG-IN	QTY	N.W	G.W	CBM	SIZE
Uni	1	0.32kg	0.40kg	0.002	110x70x450mm
10.055				50 w	
10.056					

**PLUG-IN SPOTLIGHT FOR ROLL UP**  



**SPOTLIGHT DETAILS**



**LED**

with clamp

**INFORMATION** \*mm

LED light spotlight with clamp adjustment for Roll Up. Works directly plugged in. Chrome finish and 12w LED light. With clamp for quick and easy use.



LED CLAMP	QTY	N.W	G.W	CBM	SIZE
Packing	1	0.4kg	0.8kg	0.008	100x90x500mm
10.687				12 w	

**LED CLAMP SPOTLIGHT FOR ROLL UP**



**SPOTLIGHT DETAILS**



adjustable length

2 top of pole adapters

**INFORMATION** \*mm

60w halogen bulb included. Telescopic (adjustable length). With 2 adapters for tops of the pole (plug-in and cap bases). Ideal to fit most Roll Ups on market. Large luminous capacity.



TELESCOPIC	QTY	N.W	G.W	CBM	SIZE
Packing	1	0.30kg	0.35kg	0.001	125x65x200mm
10.525				60 w	  

**TELESCOPIC SPOTLIGHT FOR ROLL UP**



\* Roll Up not included

### HANGER DETAILS



### INFORMATION

Acrylic Brochure Holder for A6 leaflet size. Double magnet fixing system. No tools required. Ideal for any Roll Up.



MAGNET DIMENSIONS	QTY	N.W	G.W	C.B.M	SIZE
Packing	5	0.05kg	0.08kg	0.004	103x100x25mm
10.860	Graphic Size: A6		x5		

## MAGNETIC BROCHURE HOLDER



## BAG FOR SPOTLIGHT ROLL UP

### BAG DETAILS



easy transport by handle



### INFORMATION

The Oxford Bag is made of black nylon and all crossed zipped. It protects and extends the life of your Roll Up Spotlights. Easy transport by handle.



OXFORD BAG	QTY	N.W	G.W	C.B.M	SIZE
Packing	1	1.10kg	0.20kg	0.002	190x310x170mm
13.454					

## GRAPHIC CASE

### CASE DETAILS





### INFORMATION

Graphics case made of sturdy PVC. Features a shoulder strap for better carrying. Available in two colours (black and grey) and three different sizes.

GRAPHIC CASE 1	QTY	N.W	G.W	C.B.M	SIZE
Um.	1	0.4kg	0.45kg	0.006	300x100x40mm
10.074	Ø107mm 540-1070mm				
10.075					
GRAPHIC CASE 2	QTY	N.W	G.W	C.B.M	SIZE
Um.	1	0.5kg	0.55kg	0.008	300x100x70mm
10.076	Ø107mm 779-1280mm				
10.077					
GRAPHIC CASE 3	QTY	N.W	G.W	C.B.M	SIZE
Um.	1	0.3kg	0.32kg	0.004	80x100x30mm
10.078	Ø85mm 830-1070mm				
10.079					

\* Roll Up case included / Roll Up case not included / Roll Up case included / Roll Up case not included



DISPLAY DETAILS



LED

INFORMATION

Re-writable and erasable Led Board, Daganzo is available in A4 and A5 format. Featuring 12 modes of bright Neon Effects. It includes rechargeable battery, marker and screen eraser. Daganzo is ideal for promoting upcoming shows, special offers, dinners, special drinks at your bar or restaurant, or at party drawing as notice board and more.



DAGANZO A5	QTY	N.W.	G.W.	C.B.M.	SIZE
Packing	40	1.0kg	5.0kg	0.1	440x420x530mm
Utl.	1	0.09kg	0.36kg	0.003	170x000x220mm

10.308 Graphic Size: A5

DAGANZO A4	QTY	N.W.	G.W.	C.B.M.	SIZE
Packing	20	1.0kg	25.0kg	0.09	480x360x440mm
Utl.	1	0.09kg	1.00kg	0.05	200x000x140mm

10.307 Graphic Size: A4

DAGANZO LED WRITING BOARD

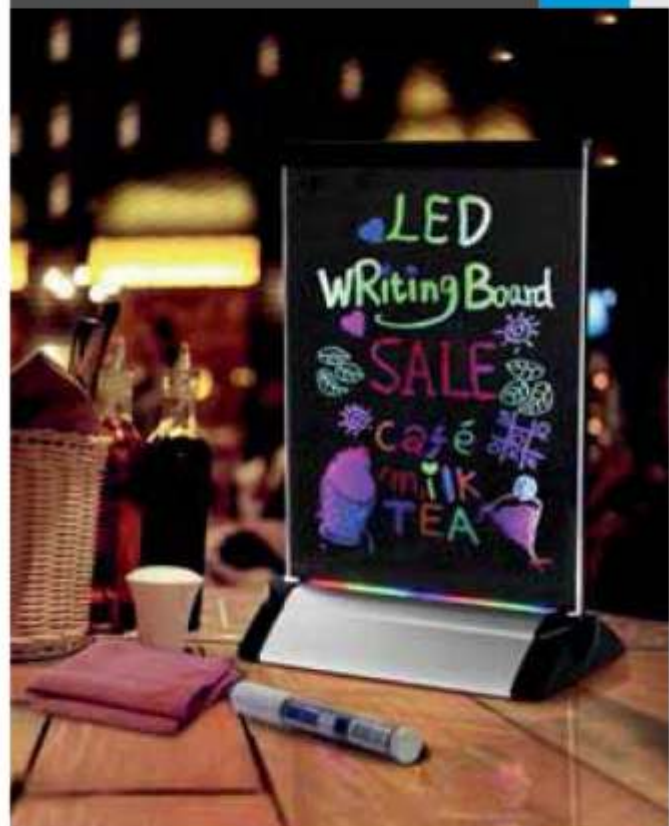

DISPLAY DETAILS



INFORMATION

This portable and retractable display for interchangeable graphics is made of aluminium and plastic parts. It is available in 2 sizes: A3 and A4. Ideal for promoting special offers or for promoting business.



TORRICO A4	QTY	N.W.	G.W.	C.B.M.	SIZE
Packing	50	19kg	17kg	0.069	525x250x500mm
Utl.	1	0.3kg	0.4kg	0.001	90x65x260mm

10.787 Graphic Size: A4

TORRICO A3	QTY	N.W.	G.W.	C.B.M.	SIZE
Packing	50	11.5kg	19kg	0.0881	705x250x500mm
Utl.	1	0.23kg	0.6kg	0.004	90x45x145mm

10.786 Graphic Size: A3

TORRICO MINI ROLL UP



DISPLAY DETAILS



INFORMATION

\*mm

Mini Flying Banner with steel base and fiberglass flag pole. It is recommendable to print the graphic part on textile. Ideal for promotional use on counters or desks. Graphic printing not included.



KRAKOW	QTY	N.W	G.W	C.B.M	SIZE
Packing	1	0.30kg	0.36kg	0.0003	30x2x150mm
10.595	Graphic Size: 550mm (Height)				

KRAKOW  
MINI FLYING



DISPLAY DETAILS



INFORMATION

\*mm

Mini X-Banner with fiberglass structure and plastic parts. It offers the possibility of exchanging the graphics easily. Ideal for promotional use on counters or desks.



TORDESILLAS	QTY	N.W	G.W	C.B.M	SIZE
Packing	200	10kg	18kg	0.02	380x80x600mm
Uni.	1	0.05kg	0.09kg	0.00045	45x35x28mm
10.009	Graphic Size: 220x400mm				

TORDESILLAS  
MINI X-BANNER



# STAND DISPLAYS Stand displays

**DISPLAY DETAILS**



**INFORMATION** \*mm

Double-sided banner display made of durable aluminium and plastic parts. Easy to assemble and graphic change. Carry bag is included. Ideal for trade shows, expositions, retail stores or any media event.



TORMES	QTY	N.W.	G.W.	C.B.M	SIZE
Packing	10	14,52kg	18kg	0,08	140x240x980mm
Utl.	1	145kg	180kg	0,007	8561x1930mm

**10.010**      Graphic Size: 600x1700mm



**DISPLAY DETAILS**



**INFORMATION** \*mm

Double-sided banner display made of durable aluminium and plastic parts. Easy to assemble and graphic change. Carry bag is included. Ideal for trade shows, expositions, retail stores or any media event.



ALMEIDA	QTY	N.W.	G.W.	C.B.M	SIZE
Packing	10	26kg	29kg	0,3	140x260x280mm
Utl.	1	260kg	290kg	0,014	120x900x170mm

**10.708**      Graphic Size: 1000x2000mm



# STAND DISPLAYS Stand displays

**DISPLAY DETAILS**



**INFORMATION** \*mm

Triple-sided banner display made of durable aluminium structure and plastic parts. Easy to assemble and change graphics. Carry bag is included.



top view

GALENDE	QTY	N.W	G.W	C.B.M	SIZE
Packing	5	14kg	16kg	0.054	400x150x1000mm
Div.	1	2.6kg	3.0kg	0.008	180x110x600mm
10.012	Graphic Size: 915x2150mm (x3)				

## GALENDE TRIPLE BANNER



**DISPLAY DETAILS**



**INFORMATION**

This display features 4 folding sections for storage with 8 double-sided panels (total one side: 2400x1800mm). Included carrying bag for an easy transporting. Grey RAL 9006 color.



SAFE ZONE  
TOTAL GRAPHIC

ARENAS	QTY	N.W	G.W	C.B.M	SIZE
Packing	1	7.3kg	11kg	0.02	640x200x950mm
10.041	Graphic Size: 2400x1800mm				

## ARENAS EXHIBITION WALL



# STAND DISPLAYS Stand Displays

## DISPLAY DETAILS



## DIMENSIONS

\*mm



9mm Max. Graphic's Thickness



9mm Max. Graphic's Thickness

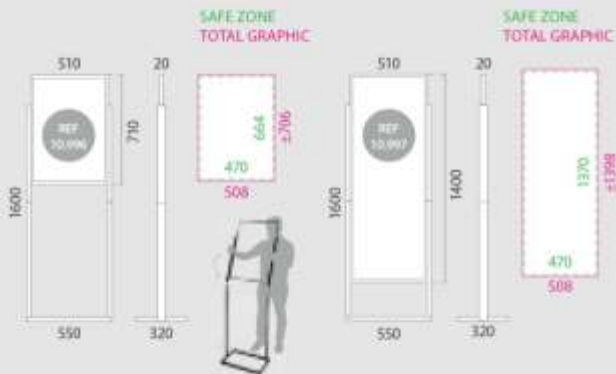

## INFORMATION

These solid Displays are made of steel and they are black painted, featuring two different graphic size available. Slide the poster (9mm max. thickness) into the grooves and display it back-to-back in high traffic areas.

STEEL 01	QTY	N.W	G.W	C.B.M	SIZE
Packing	1	10.09kg	11.20kg	0.066	570x46x115mm
10.996	Graphic Size: 508 x ±706mm				
STEEL 02	QTY	N.W	G.W	C.B.M	SIZE
Packing	1	11.30kg	12.47kg	0.066	570x46x115mm
10.997	Graphic Size: 508 x ±1398mm				

## STEEL STAND DISPLAY





**ALUMINIUM BANNER DISPLAY**

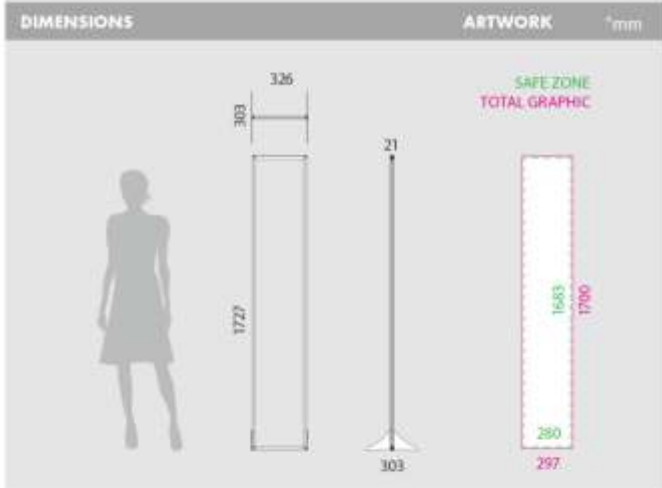

**INFORMATION**

Aluminium Banner Display is lacquered in gray RAL 9006 and features an easy to load and upload system. With an easy glide for the 1700mm height graphic poster (5mm max.thickness) into the metal grooves of the structure and display it back-to-back in high traffic areas. This Aluminium Banner Display is ideal for displaying at mall's corridors, for promoting at-trade shows, outside your office or showroom.

K.BANNERD	QTY	N.W	G.W	C.E.M	SIZE
Packing	1	1.8kg	2.3kg	0.0205	1745x135x35mm
13.643		Graphic Size: 297x1700mm			



# STAND DISPLAYS Stand Displays

## ALUMINIUM STAND DISPLAY

### DISPLAY DETAILS



### DIMENSIONS

### ARTWORK <sup>1</sup>mm

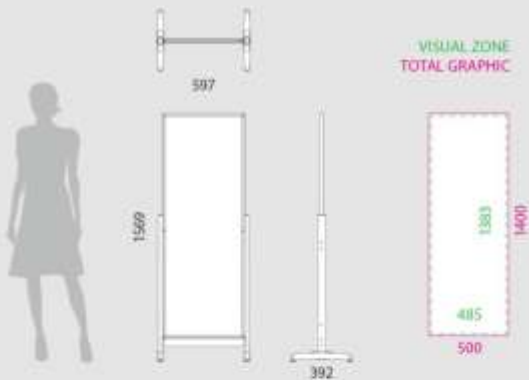

### INFORMATION

Aluminium Stand Display lacquered in gray RAL 9006, featuring an easy to load and upload system. With adjustable stability sturdy feet and an easy glide height graphic poster (3mm max thickness) into the metal grooves of the structure and display it back-to-back. Ideal for promoting at trade shows, retail stores, fair stands, showrooms, travel agencies or offices.

A STAND	QTY	N.W	G.W	C.B.M	SIZE
Packing	1	4.47kg	5.54kg	0.0436	880x660x75mm

13.736 - Graphic Size: 500x1400mm



## MEDIA FRAME

### DISPLAY DETAILS



### DIMENSIONS

\*mm

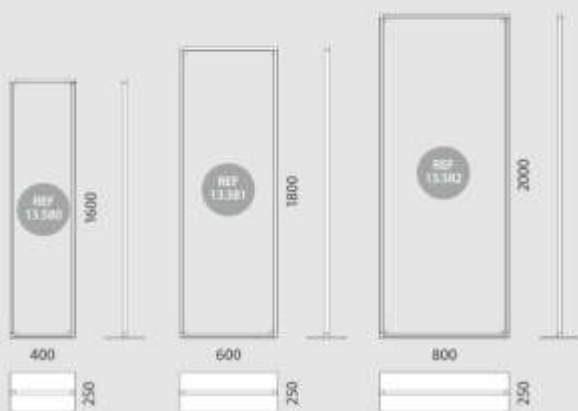

### INFORMATION

This closed frame support is made of aluminium and it is suitable for PVC graphic posters, fixed with magnetic tape. Also, it features a stylish and sturdy flat base. Media Frame is ideal for using during a variety of promotional events, such as a trade shows, media events, expositions or even as solution for a photocall.

MODEL	QTY	N.W	G.W	C.B.M	WE
Packing	1	7,5kg	8kg	0,078	400x800x60mm
13.580		Graphic Size: 400x1600mm			
MODEL	QTY	N.W	G.W	C.B.M	WE
Packing	1	10kg	11kg	0,095	600x900x60mm
13.581		Graphic Size: 600x1800mm			
MODEL	QTY	N.W	G.W	C.B.M	WE
Packing	1	13kg	14kg	0,043	800x800x60mm
13.582		Graphic Size: 800x2000mm			



\*PVC sheet and magnetic tape not included



## DISPLAY DETAILS



## DIMENSIONS

## ARTWORK

\*mm

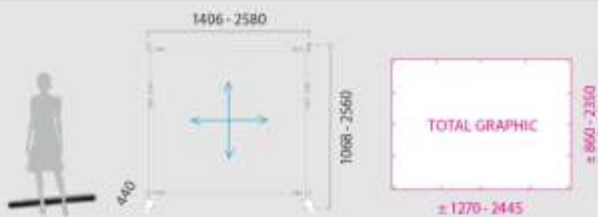

## INFORMATION

With structure made of steel and black laquered. This portable and double-sided banner is ideal for using during a variety of promotional events, such as a trade show, media event, tradeshow exposition or even as solution for a photocall. Each pipe is also designed for an easy and fast telescopic adjustment of the display, allowing the use of graphs of different widths and heights. Vilamoura banner is a display fast to assemble and easy to transport. Adjustable height and width structure. Minimum graphic size: ± Height 860 x Width 1270mm. Maximum graphic size: ± Height 2350 x Width 2445mm.

VILAMOURA	QTY	N.W	G.W	C.F.M	SIZE
Packing	2	11kg	13kg	0,031	140x20x380mm
Unit	1	5,5kg	6kg	0,015	170x170x380mm
10.498		Graphic Size: 1270-2445x860-2350mm			

## VILAMOURA EXTENSION BANNER



DISPLAY DETAILS



DIMENSIONS

ARTWORK

mm

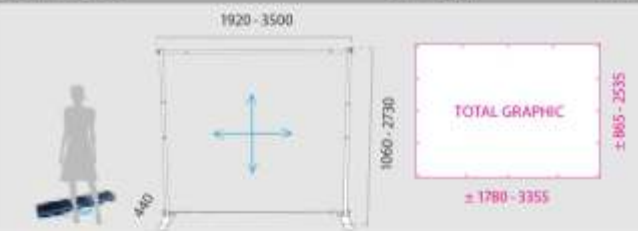

INFORMATION

With structure made of aluminium and plastic. Available black or silver finishing. This portable and double-sided banner is ideal for using during a variety of promotional events: such as a trade show, media event, tradeshow exposition or even as solution for a photocall. Each pipe is also designed for an easy and fast telescopic adjustment of the display, allowing the use of graphs of different widths and heights. Vilamoura XXL banner is a big size display fast to assemble and easy to transport, ideal for any promotional event that your business requires. Adjustable height and width structure. Minimum graphic size: ± Height 1315 x Width 1780mm. Maximum graphic size: ± Height 2535 x Width 3355mm.

VILAMOURA XXL	QTY	N.W	G.W	C.B.M	SIZE
Packing	1	7kg	8.8kg	0.0268	230x110x1050mm
13.752		Graphic Size: 1780-3355x865-2535mm			

VILAMOURA XXL  
EXTENSION BANNER



# STAND DISPLAYS Stand Displays

**DISPLAY DETAILS**



**INFORMATION**

This double sided Poster Display is made of metal, suitable for 2 exhibitions of graphics. It features a telescopic pole (adjustable height of 1000-1600mm).

**DIMENSIONS**

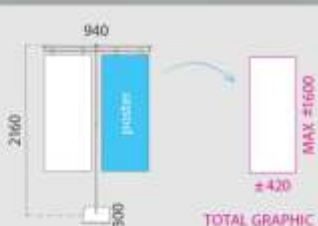

**ARTWORK** \*mm

MAX ±1600  
±420  
TOTAL GRAPHIC

ALGORA	QTY	N.W	G.W	C.B.M	Q'ZE
Packing	1	1,2kg	15kg	0,02	270x70x200mm
10.803	Graphic Size: ±420x1000-1600mm (x2)				



**DISPLAY DETAILS**



**INFORMATION**

Oropesa Poster Display is made of metal, featuring a special design for an optimum storage. Also, it has a telescopic pole with adjustable height (1100-2100mm). Ideal for promoting your business, such as tradeshows and promotional events at stores or business presentations.

**DIMENSIONS**



**ARTWORK** \*mm

MAX ±2100  
±360  
TOTAL GRAPHIC

OROPESA	QTY	N.W	G.W	C.B.M	Q'ZE
Packing	1	1,9kg	2,53kg	0,05	400x330x185mm
10.432	Graphic Size: ±360x1100-2100mm				



# STAND DISPLAYS Refillable Base Banner

### DISPLAY DETAILS



### INFORMATION

\*mm

This portable and detachable display stand features a water refillable base, 6 litres capacity. Made of fiberglass, plastic and lacquered aluminium. Suitable for indoor and outdoor use, features an easy interchange of graphics. Carry bag is included.



ALMAZAN	QTY	NW	GW	CBM	SD
Frame	1	0.50kg	0.8kg	0.004	80x65x130mm
Base	1	0.9kg	1kg	0.05	250x170x250mm

10.028      Graphic Size: 600x1800mm



### DISPLAY DETAILS



### INFORMATION

\*mm

This portable and detachable display stand features a water refillable base, 6 litres capacity. Made of fiberglass, plastic and lacquered aluminium. Suitable for indoor and outdoor use, features an easy interchange of graphics and adjustable height (telescopic). Carry bag is included.



ALMENAR	QTY	NW	GW	CBM	SD
Packing	6	19kg	16.20kg	0.1	400x320x850mm
Unit	1	3.1kg	2.7kg	0.02	280x100x840mm

10.029      Graphic Size: 800x1900mm



# STAND DISPLAYS Refillable Base Banner

## DISPLAY DETAILS



## INFORMATION

\*mm

This stand display features a 20l water refillable base. The central telescopic hub allows fast height adjustment. Kiel is ideal for indoor or outdoor promotion, and as it can be used to present a double-sided graphic (ideal for areas with 2-ways traffic). Graphics are held with a simple and fast eyelet system. In double-sided Kiel 10.574, after the placement of graphs, the distance to the ground on both sides can differentiate each other:  $\pm 50$ mm.

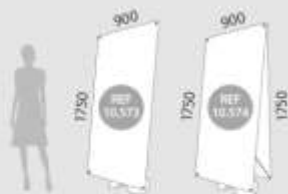

SKU	QTY	N.W.	G.W.	C.B.M.	SIZE
Packing	1	2.8kg	3.25kg	0.08	400x200x1080mm
10.573	Graphic Size: 900x1750mm				
SKU	QTY	N.W.	G.W.	C.B.M.	SIZE
Packing	1	3kg	3.45kg	0.09	410x200x1080mm
10.574	Graphic Size: 900x1750mm x2				

## KIEL



# STAND DISPLAYS Refillable Base Banner

### DISPLAY DETAILS



### INFORMATION

Medinaceli is a detachable stand display with a refillable 12l water plastic base which is suitable for indoor and outdoor use. The change of graphic is simple and takes only a few seconds. Includes a nylon Carry Bag for an easy transport and storing.



MEDINACELI	QTY	N.W	G.W	C.B.M	SIZE
Packing	2	3kg	10kg	0.15	540x90x1050mm
Unit	1	2.05kg	3.90kg	0.05	500x100x1030mm

10.025      Graphic Size: 450x1560mm



### BASE DETAILS



### INFORMATION

With a durable design and easy portability, this double-sided base with corrugated plastic insert is ideal for placing outdoors, in areas with high foot traffic to draw in new customers. The weighted poster holder can be filled with up to 5l of water or sand. This base is available on Grey or black color.



PANELFIX WING	QTY	N.W	G.W	C.B.M	SIZE
Packing	1	2kg	2.55kg	0.04	440x190x520mm

10.442      

10.443      



\* Base are available but not included. The price includes only the base.

# STAND DISPLAYS Display Bases

## BASE DETAILS



## INSTALL EXPLANATION FOR PANELS UP TO 18mm

1. Place the profile below.
2. Adjust the profile with wheel at the bottom of the Panelfix Wing Aluminium.
3. Max. thickness: 18mm.
4. Place the graphic panel into the slot and adjust it with the wheel until it is properly fixed.

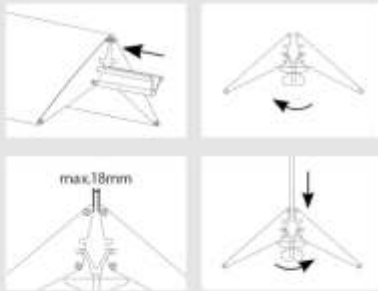

## INSTALL EXPLANATION FOR PANELS UP TO 26mm

1. Place the profile above.
2. Adjust the profile with wheel at the bottom of the Panelfix Wing Aluminium.
3. Max. thickness: 26mm.
4. Place the graphic panel into the slot and adjust it with the wheel until it is properly fixed.

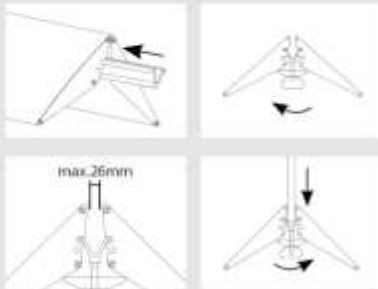

## INFORMATION

The Panelfix Wing base made of aluminium is available in three sizes 200, 350 or 550mm and two colors: black or silver. It is designed to hold rigid graphs, allowing the fixing of supports up to 26mm thickness. Also, it allows the printing of any logo on both sides of the base. The double-sided signs help to draw more potential customer coming from both directions into your business.

R	AL 200	QTY	N.W	G.W	C.B.M	SIZE
	Packing	1	1.7kg	1.6kg	0.0068	355x93x239mm
10.828		Width: 200mm				
10.829						
R	AL 350	QTY	N.W	G.W	C.B.M	SIZE
	Packing	1	2.6kg	3kg	0.013	355x93x355mm
10.877		Width: 350mm				
10.869						
R	AL 550	QTY	N.W	G.W	C.B.M	SIZE
	Packing	1	4.32kg	4.6kg	0.021	355x93x595mm
10.880		Width: 550mm				
10.870						

## PANELFIX WING ALUMINIUM



# STAND DISPLAYS Display Bases



## PANELFIX WING STEEL

### BASE DETAILS



### DIMENSIONS

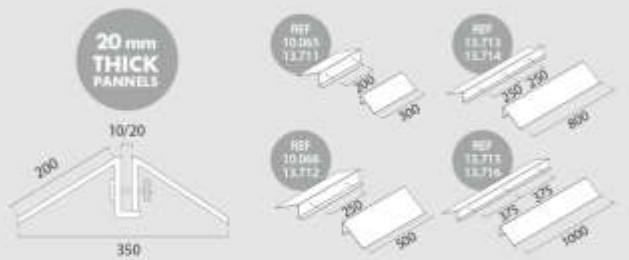

### INFORMATION

The Panelfix Wing is a display base made of steel with four available sizes from 300 up to 1000mm and two colors for each size: black or gray. It is designed to hold rigid graphs, allowing the fixing of supports up to 20mm thickness (the max. recommended height is 1500mm). Also, it allows the printing of any logo on both sides of the base. The double-sided signs help to draw more potential customer coming from both directions into your business. The steel base of this sign holder are sturdy enough for multiple uses and years to come, from a crowded trade show floor to a fast paced retail store.

REF	QTY	N.W	G.W	C.B.M	SIZE
Packing	1	2.7kg	2.9kg	0.0069	200x100x330mm
10.065		Grey	Width: 300mm		
13.711		Black			
REF	QTY	N.W	G.W	C.B.M	SIZE
Packing	1	4.58kg	4.8kg	0.0111	510x210x330mm
10.066		Grey	Width: 500mm		
13.712		Black			
REF	QTY	N.W	G.W	C.B.M	SIZE
Packing	1	7.8kg	7.8kg	0.0243	830x250x330mm
13.713		Grey	Width: 800mm		
13.714		Black			
REF	QTY	N.W	G.W	C.B.M	SIZE
Packing	1	8.85kg	9.8kg	0.0302	1030x250x330mm
13.715		Grey	Width: 1000mm		
13.716		Black			



\* Base is available but not included. The price include only the item.



# STAND DISPLAYS Display Bases

## BASE DETAILS



## DIMENSIONS

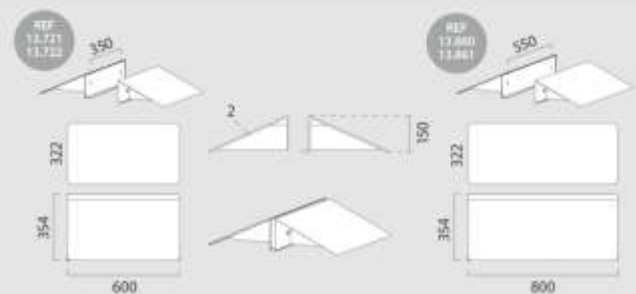



## INFORMATION

This base is made of steel sheet of 2mm thickness and it is available in two widths (600 mm and 800mm). It features black laquered (RAL 9005) or grey laquered (RAL 9006). The XL Steel base is ideal to hold rigid materials up to 19mm thickness. The maximum recommended height for the graphic board is 2000mm. Specially designed for supporting big graphic panels thanks to its weight. This base is a simple clip holder system that grips a board between the two sides to help businesses advertise their products and services. Ideal as a sleek, professional alternative to bulky A-frame Board poster stands.

REF XL 600	QTY	N.W	G.W	C.F.M	SIZE
Packing	1	7,85kg	12,55kg	0,0465	400x90x640mm
13.721		Grey	600x663x150mm		
13.722		Black			

REF XL 800	QTY	N.W	G.W	C.F.M	SIZE
Packing	1	14,25kg	19kg	0,064	400x90x640mm
13.860		Grey	800x663x150mm		
13.861		Black			

**new**

## PANELFIX WING STEEL XL



\* Boards are available but not included. The price is only for the base.

BASE DETAILS



DIMENSIONS

mm

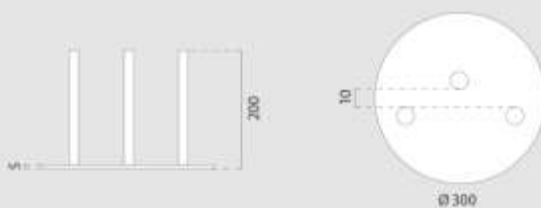

INFORMATION

The Montijo Poster Display is a Ø300mm base made of 5mm thickness steel sheet. It is 200mm height and is available in black or white colored. It is ideal for holding rigid materials up to 10mm thickness and includes anti-scratch felt pads at bottom. The double-sided signs help to draw more potential customer coming from both directions into your business. The steel base of this sign holder are sturdy enough for multiple uses and years to come, from a crowded trade show floor to a fast paced retail store.

MONTIJO	QTY	NW	GW	CBM	NET
Packing	2	7.2kg	17.5kg	0.024	210x290x310mm
10.898	<input checked="" type="checkbox"/>				
10.838	<input type="checkbox"/>				

Size: Ø300x200mm x2

MONTIJO



\* Base(s) are available but not included. The price exclude only the item.

# BALBOA



## BASE DETAILS



## DIMENSIONS

\*mm

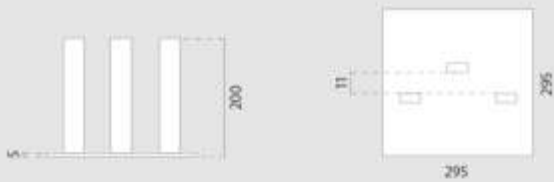

## INFORMATION

This base is made of 5mm thickness steel sheet. It features anti-scratch felt pads at bottom. Available in black or white colored. The steel base of this sign holder are sturdy enough for multiple uses and years to come, from a crowded trade show floor to a fast paced retail store. The Balboa base is ideal to hold rigid materials up to 11mm thickness.

BALBOA	QTY	NW	GW	C/M	SIZE
Packing	2	0.00kg	0.00kg	0.024	30x250x180mm
10.894	<input checked="" type="checkbox"/>	295x200x295mm		x2	
10.895	<input type="checkbox"/>				



\* Boards are available but not included. The price includes only the base.

BASE DETAILS



DIMENSIONS

\*mm

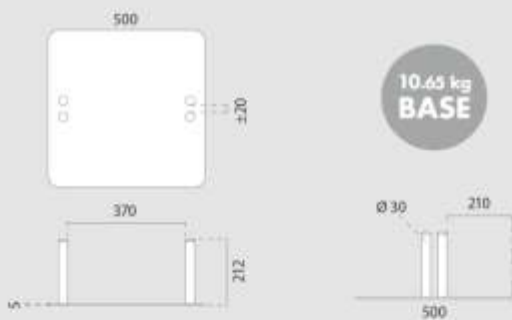

INFORMATION

The Balboa XL is made of steel sheet of 5mm thickness. It features black laquered (RAL 9005) or grey laquered (RAL 9006) finish. This XL Steel base is ideal to hold rigid materials up to 19mm thickness. Specially designed for supporting big graphic panels (2000mm max. height recommended) thanks to its 10.65kg.

BALBOA XL	QTY	N.W	G.W	C.B.M	SIZE
Packing	1	11.31kg	12.70kg	0.0772	545x545x200mm
13.723		Grey	500x212x500mm		
13.724		Black			

BALBOA XL



\* Base in white available but not included. The price includes only the item.

# SIDEWALK BOARDS Click Boards

## SIDEWALK DETAILS



## SIDEWALK DETAILS

## GRAPHIC BY CLICK FRAME



## DIMENSIONS

\* W: Width H: Height D: Depth \* mm

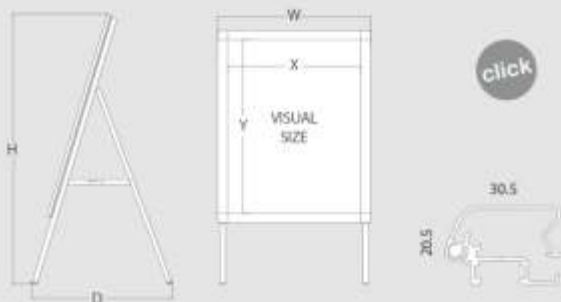

## INFORMATION

This frame board is made of aluminum so it is lightweight and resistant to rusting. It has a 30.5mm width profile with click system, so the graphic change is quick and simple. With its single-sided folding frame, Niza A-Board is ideal for advertising outside your store, like restaurants, street stalls or supermarkets. It includes a weather resistant antireflection sheet so is also non-glare which allows it to be read under bright lights.

NIZA	Qty	N.W	G.W	C.B.M	Size (WxHxD)
Packing	1	3kg	7kg	0.075	580x1080x20
		Visual (X-Y)	External (WxHxD)		
Product		482x685	540x1080x440		
10.808		Graphic Size: 500x700mm			

## NIZA



# SIDEWALK BOARDS Click Boards

## SIDEWALK DETAILS



## DIMENSIONS

\* W: Width H: Height D: Depth \* mm

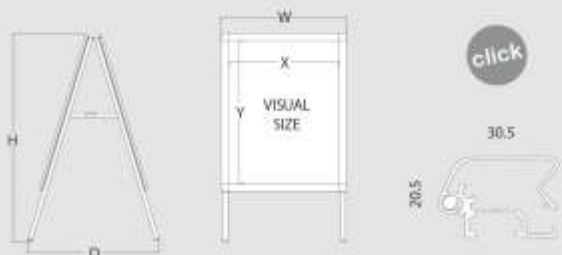

## INFORMATION

Bayonne Sidewalk is made of aluminum so it is lightweight and resistant to rusting. It has feet protection to avoid slipping and a 30.5mm width profile with click system, so the graphic change is fast and simple. Also, it includes a weather resistant antireflection sheet so is also non-glare which allows it to be read under bright lights. With its 2-sided folding frame, The Bayonne Sidewalk is ideal for advertising sales inside or outside your store.

MODEL	QTY	N.W.	G.W.	C.B.M.	Size (WxHxD)
Packing	1	4.85kg	6.5kg	0.068	500x700x20
		Visual (X-Y)	External (WxHxD)		
Product	485x685		645x700x332		

10.804 Graphic Size: 500x700mm

MODEL	QTY	N.W.	G.W.	C.B.M.	Size (WxHxD)
Packing	1	7.64kg	9.6kg	0.127	700x1000x25
		Visual (X-Y)	External (WxHxD)		
Product	687x988		745x1100x105		

10.805 Graphic Size: 700x1000mm

MODEL	QTY	N.W.	G.W.	C.B.M.	Size (WxHxD)
Packing	1	6.7kg	8.5kg	0.101	598x838x20
		Visual (X-Y)	External (WxHxD)		
Product	580x830		640x1170x140		

13.145 Graphic Size: A1

MODEL	QTY	N.W.	G.W.	C.B.M.	Size (WxHxD)
Packing	1	10.2kg	12.45kg	0.171	838x1188x20
		Visual (X-Y)	External (WxHxD)		
Product	825x1170		885x1520x195		

13.146 Graphic Size: A0

## BAYONNE



## ANTIREFLECTION SHEET

- EN Antireflection sheet for snapframe.
- FR Antireflet pour cadres ou chevalets.
- PT Película antirreflexo para marcos e caveletes.
- ES Antirreflex para marcos y caballetes.



SHEET	SIZE
10.952	500x700mm
10.953	700x1000mm
10.992	A1   598x838mm
10.993	A0   838x1188mm

# SIDEWALK BOARDS Click Boards

**SIDEWALK DETAILS** **GRAPHIC BY CLICK FRAME**



**INFORMATION** \* W: Width H: Height D: Depth \* mm

Grenoble is a small dimensions A-frame aluminium board. It is lightweight and resistant to rusting. It has a 32mm click system profile. Grenoble is ideal for advertising events, menus or last offers outside your shop. Includes a weather resistant antireflection sheet.



REF/IDEL	QTY	N.W	G.W	C.B.M	Dim (WxHxD)
Packing	1	4.3kg	5kg	0.0374	425x880x100
		Visual (X-Y)	External (WxHxD)		
Product		34x541	404x880x55		
<b>10.942</b>	<b>Graphic Size: 340x540mm</b>				



**SIDEWALK DETAILS** **GRAPHIC BY CLICK FRAME**



**INFORMATION** \* W: Width H: Height D: Depth \* mm

Poisat is a small dimensions aluminium A-frame Board. It is lightweight and resistant to rusting. It has a 25mm width click system profillet. Ideal for advertising your upcoming events, shows, menu or last offers at your show window. It includes a weather resistant antireflection sheet.

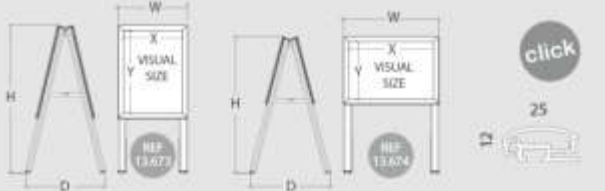

REF/IDEL	QTY	N.W	G.W	C.B.M	Dim (WxHxD)
Packing	1	2.77kg	3.29kg	0.0244	340x750x65
		Visual (X-Y)	External (WxHxD)		
Product		275x402	332x690x375		
<b>13.673</b>	<b>Graphic Size: A3 Portrait</b>				
REF/IDEL	QTY	N.W	G.W	C.B.M	Dim (WxHxD)
Packing	1	2.63kg	3.25kg	0.0208	460x670x65
		Visual (X-Y)	External (WxHxD)		
Product		275x402	456x640x91		
<b>13.674</b>	<b>Graphic Size: A3 Landscape</b>				



# SIDEWALK BOARDS Click Boards

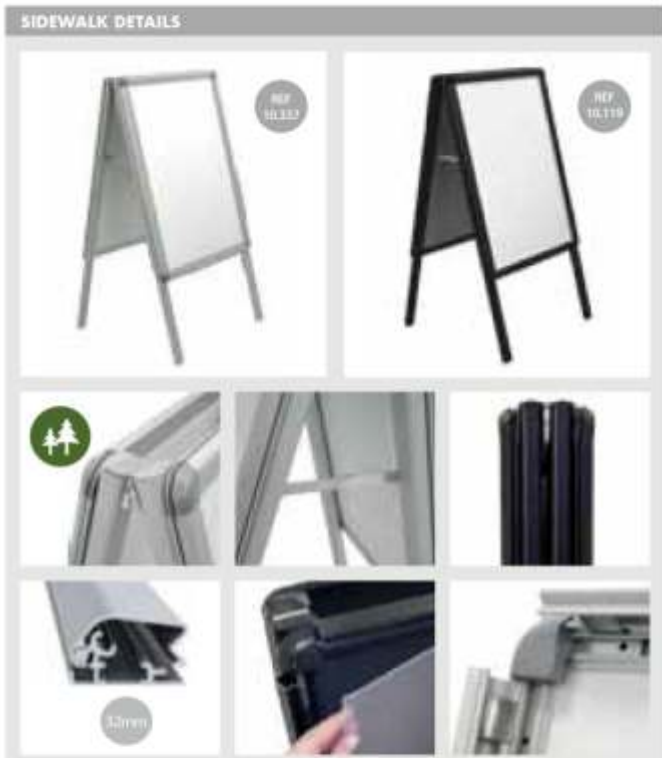

**INFORMATION** \* W: Width H: Height D: Depth \* mm

Merida has a 32mm width aluminium profile with click system, so it is lightweight and resistant to rusting. Merida has feet protections to avoid slipping and a weather resistant antireflection sheet included. It is ideal for being used inside or outside of your business.

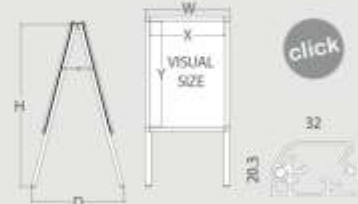

### RAL COLORS AVAILABLE



MERIDA AL	QTY	N.W	G.W	C.B.M	Size (WxHxD)
Packing	1	732kg	968kg	0.098	690x420x105
		Visual (C.V)	External (WxHxD)		
Product		575x822	638x1400x108		GRAPHIC SIZE
10.337					
10.119					A1
10.119WD					
MERIDA H100	QTY	N.W	G.W	C.B.M	Size (WxHxD)
Packing	1	1.64kg	6.7kg	0.022	575x600x45
		Visual (C.V)	External (WxHxD)		
Product		481x601	544x1050x98		GRAPHIC SIZE
10.338					
10.122					500x700mm
10.122WD					
MERIDA H1000	QTY	N.W	G.W	C.B.M	Size (WxHxD)
Packing	1	8.94kg	10.67kg	0.127	765x445x45
		Visual (C.V)	External (WxHxD)		
Product		681x601	744x1400x79		GRAPHIC SIZE
10.339					
10.124					700x1000mm
10.124WD					





# SIDEWALK BOARDS Click Boards



## DIJON

**SIDEWALK DETAILS** \* mm **GRAPHIC BY CLICK FRAME**

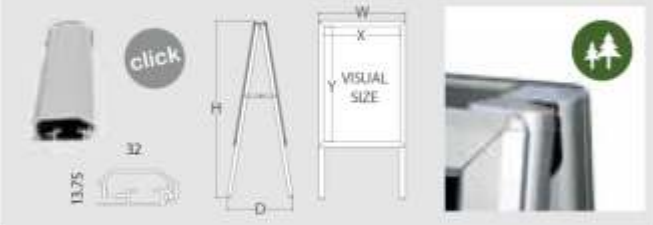

**INFORMATION**

The Dijon Sidewalk is designed for outdoor use so it's perfect for advertising outside or inside your store. It has a 32mm width aluminium profile with click system, so the graphic change is quick and simple. Thanks to its double-sided frame is ideal for displaying offers, menus, information maps, etc. It includes a weather resistant antireflection sheet.

DESCRIPTION	QTY	N.W	G.W	C.B.M	Size (WxHxD)
Packing	1	5kg	6.5kg	0.0877	580x120x65
		Visual (X-Y)	External (WxHxD)		
Product		432x678	542x1038x614		
<b>10.558</b>	<b>Graphic Size: 500x700mm</b>				
DESCRIPTION	QTY	N.W	G.W	C.B.M	Size (WxHxD)
Packing	1	6.4kg	8.5kg	0.0984	660x140x65
		Visual (X-Y)	External (WxHxD)		
Product		572x878	678x1025x131		
<b>10.557</b>	<b>Graphic Size: A1</b>				
DESCRIPTION	QTY	N.W	G.W	C.B.M	Size (WxHxD)
Packing	1	7.1kg	9.6kg	0.1367	790x185x131
		Visual (X-Y)	External (WxHxD)		
Product		678x978	742x1025x131		
<b>10.559</b>	<b>Graphic Size: 700x1000mm</b>				



**SIDEWALK DETAILS** \* mm **GRAPHIC BY CLICK FRAME**



**INFORMATION**

This double-sidewalk is made of aluminum so it is lightweight and resistant to rusting. It has a 21mm width click system profile. It features a headboard support for displaying a graphic. Ideal for outside or inside your store, restaurant, street stall or supermarket. It includes a weather resistant antireflection sheet.

DESCRIPTION	QTY	N.W	G.W	C.B.M	Size (WxHxD)
Packing	1	13.9kg	15.7kg	0.3085	690x1210x50
		Visual (X-Y)	External (WxHxD)		
Product		581x628	647x1060x123		
<b>10.235</b>	<b>Graphic Size: A1</b>				

## BELMEZ



# SIDEWALK BOARDS Click Boards



## MONTANCHEZ

### SIDEWALK DETAILS



### DIMENSIONS

\* W: Width H: Height D: Depth \* mm

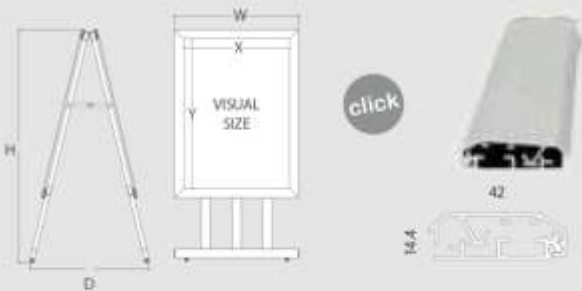

### INFORMATION

Montanchez Sidewalk features and structure made of aluminum over a steel structure so this way, its extra weight gives a great stability and it's very resistant to rusting. It has non-slip leveling feet and also a 42mm width profile with click system, so the graphic change is quick and simple. With its double-sided folding frame, Montanchez is designed especially for outdoor use so it's perfect for advertising sales and promotions outside your store. It includes a weather resistant antireflection sheet so is also non-glare which allows it to be read under the bright lights.

1100	QTY	N.W	G.W	C.B.M	Size (WxHxD)
Packing	1	11.95kg	13.1kg	0.030	560x1090x115
		Visual (X-Y)	External (WxHxD)		
Product	480x660		584x1052x524		
<b>10.127</b>	<b>Graphic Size: 500x700mm</b>				

1100	QTY	N.W	G.W	C.B.M	Size (WxHxD)
Packing	1	12.25kg	13.3kg	0.021	880x1015x100
		Visual (X-Y)	External (WxHxD)		
Product	690x960		764x1102x525		
<b>10.128</b>	<b>Graphic Size: 700x1000mm</b>				

11400	QTY	N.W	G.W	C.B.M	Size (WxHxD)
Packing	1	25.5kg	28.5kg	0.1894	1000x900x188
		Visual (X-Y)	External (WxHxD)		
Product	880x1360		1004x1302x568		
<b>10.129</b>	<b>Graphic Size: 1000x1400mm</b>				



# SIDEWALK BOARDS



Click Boards

**new**

## SIDEWALK DETAILS



## SIDEWALK DETAILS

## GRAPHIC BY CLICK FRAME



## DIMENSIONS

\* W: Width H: Height D: Depth \* mm

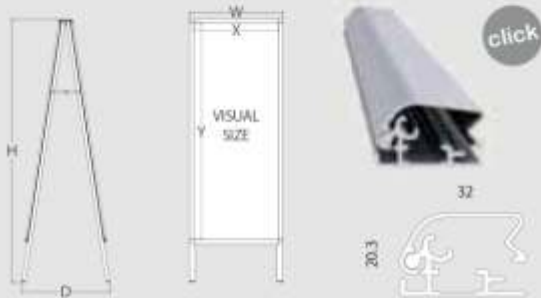

## INFORMATION

The Poznan A-board frame is made of aluminum so it is lightweight and resistant to rusting and it is available on black or silver color. It has a 32mm width profile with click system, so the graphic change is quick and simple. Thanks to its double-sided frame and its 1800mm height this A-Board is ideal for advertising large offers, menus, information maps, etc. outside or inside your business. It includes a weather resistant antireflection sheet so it is also non-glare which allows it to be read under bright lights.

POZNAN	QTY	N.W.	G.W.	C.B.M.	Size (WxHxD)
Packing	1	12.9kg	14.8kg	0.177	705x1800x32
		Visual (X:Y)	External (WxHxD)		
Product		180x1811	844x1800x600		
10.343			Graphic Size: 600x1500mm		

POZNAN



# SIDEWALK BOARDS Click Boards

## SIDEWALK DETAILS



## DIMENSIONS

\* W: Width H: Height D: Depth \* mm.

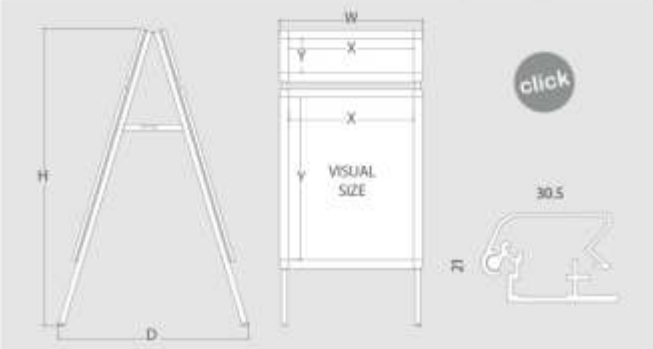

## INFORMATION

Toulouse double-Sidewalk is made of aluminum so it is lightweight and resistant. It has a 30.5mm width profile with click system, so the graphic change is quick and simple. Also it includes a resistant antireflection sheet so is also non-glare which allows it to be read under bright lights. Features a headboard support for displaying company logos or graphs. Ideal for displaying sales or promotions at restaurants, stores, shops or supermarkets.

TOULOUSE	QTY	R.W	G.W	C.B.M	Size (WxHxD)
Packing	1	3kg	7kg	0.100	610x25x380
		Board Visual (X*Y)	Upper Visual (X*Y)		External (WxHxD)
Product		485x685	485x685		545x210x630
10.806		Board Graphic Size: 500x700mm			Upper Graphic Size: 500x200mm

## TOULOUSE



# SIDEWALK BOARDS Click A-Board



## MOTA SINGLE-SIDED

### DISPLAY DETAILS

### CLICK FRAME PROFILE DETAILS

### DIMENSIONS

\* W: Width H: Height D: Depth \* mm

### INFORMATION

This anodized aluminium A-Board is very lightweight, foldable for an easy storage and very resistant to rusting. It features a 25mm width profile with click system, so the graphic change is quick and simple. Also it includes a weather resistant antireflection sheet. The Mota A-Board range features 2 configurations of A3 frames. They are ideal for advertising sales or special promotions inside or outside your business. It's perfect for restaurants, stalls, stores or for any marketplace.

MOTA A3set	QTY	N.W	G.W	C.B.M	Size (WxHxD)
Packing	1	4.2kg	5.218kg	0.0068	435x1255x95
Product					Visual (X-Y) External (WxHxD)
13.670					Graphic Size: A3 x3

MOTA A3set	QTY	N.W	G.W	C.B.M	Size (WxHxD)
Packing	1	5.7kg	6.7kg	0.0722	435x1600x95
Product					Visual (X-Y) External (WxHxD)
10.216					Graphic Size: A3 x4



# SIDEWALK BOARDS Click A-Board

**new**



## MOTA DOUBLE-SIDED

**SIDEWALK DETAILS**

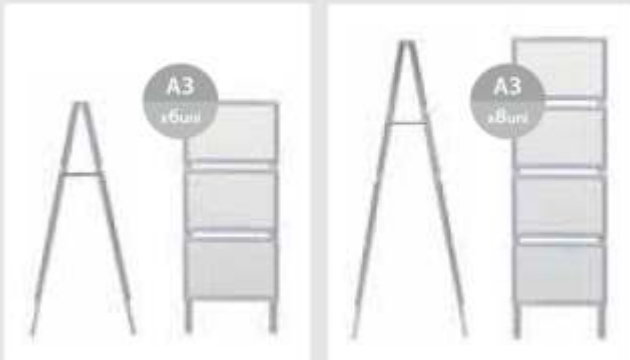

**CLICK FRAME PROFILE DETAILS**



**DIMENSIONS** \* W: Width H: Height D: Depth \* mm

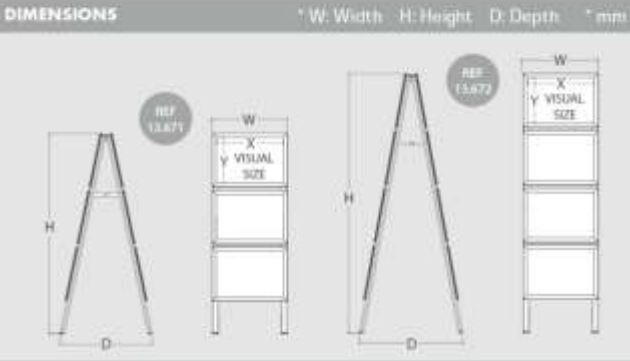

**INFORMATION**

This anodized aluminium A-Board is very lightweight, foldable for an easy storage and very resistant to rusting. It features a 25mm width profile with click system, so the graphic change is quick and very simple. Also it includes a weather resistant antireflection sheet so is also non-glare which allows it to be read under bright lights. The Mota A-Board range features 2 configurations of A3 frames. They are ideal for advertising sales or special promotions inside or outside your business. It's perfect for restaurants, stalls, stores or for any marketplace.

MOTA A3 3+3	QTY	N.W	G.W	C.B.M	Size (WxHxD)
Packing	1	5.4kg	7.419kg	0.0986	475x1255x95
Product		402x279	455x1070x653		
13.671 Graphic Size: A3 3+3					
MOTA A3 4+4	QTY	N.W	G.W	C.B.M	Size (WxHxD)
Packing	1	8.3kg	9.529kg	0.0722	475x1600x95
Product		402x279	455x1537x619		
13.672 Graphic Size: A3 4+4					



SIDEWALK DETAILS



with rechargeable battery



DIMENSIONS

\* W: Width H: Height D: Depth \* mm

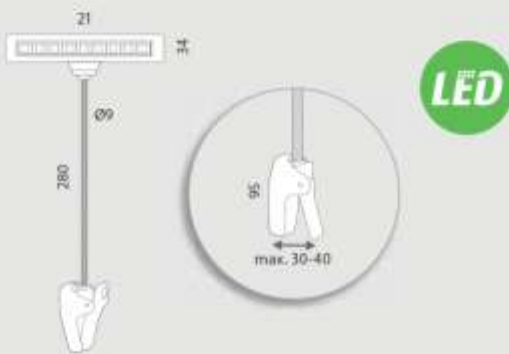

INFORMATION

The Portable and rechargeable 1,8W LED Lamp is a very useful accessory for any display, has an autonomy of more than 5 hours and three levels of brightness (featuring a charging indicator display). With a stunning black finish, this portable LED Lamp will add a touch of distinction and functionality to your display. Thanks to its low consumption and its high strength clamp (3-4cm maximum grip) it can be coupled to a wide range of display products, among them Frame Boards, Blackboards, Photocalls, Lecterns or Counters.

SPOTLIGHT	CITY	N.W.	G.W.	C.B.M.	Size (WxHxD)
Packing	1	0,38kg	0,40kg	0,0004	180x227x70
13.642					

PORTABLE LED LAMP



14.111  
A-BOARD SPECIAL TOP  
Seen in BLACKBOARDS



13.641  
WOODEN FAST LECTERN  
LECTERNS  
Seen in FRAMES & INFORMATIVE HOLDERS



10.996  
STEEL DISPLAY  
POSTER DISPLAY  
Seen in STAND DISPLAYS



# IBAHERNANDO



**DIMENSIONS** \* W: Width H: Height D: Depth \* mm

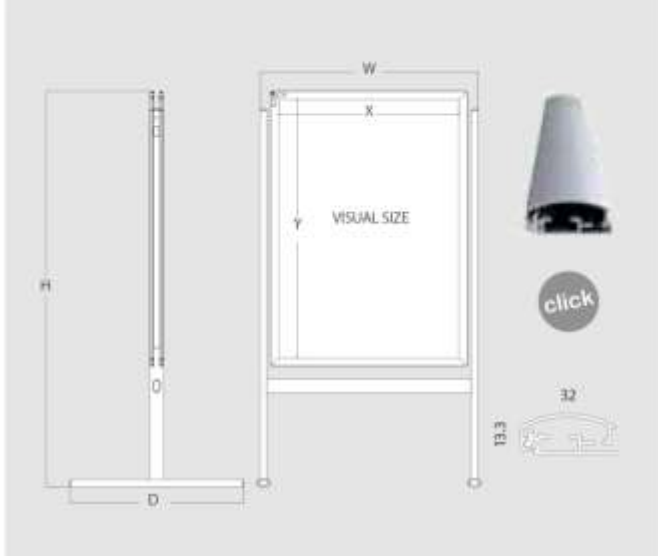

**INFORMATION**

The Ibahernando Sidewalk is made of aluminum so it is lightweight and resistant to rusting and wind thanks its strong 847mm length feet. It features a 32mm width profile with click system, so the graphic change is fast and simple y a few seconds. Also it features a revolving board design and it includes a resistant antireflection sheet so is also non-glare which allows it to be read under bright lights. Ibahernando Sidewalk is ideal for displaying sales or promotions at restaurants, stores, shops or at supermarkets.

IBAHERNANDO	QTY	N.W	G.W	C.B.M	Sm Boxes/20
Packing:	1	90kg	110kg	0,141	871x1525x105
	Visual (X-Y)	External (WxHxD)			
Product:	881x1065	825x1065x847			
10.165	Graphic Size: 700x1000mm				



# SIDEWALK BOARDS Click Boards

## SIDEWALK DETAILS



**DIMENSIONS** \* W: Width H: Height D: Depth \* mm

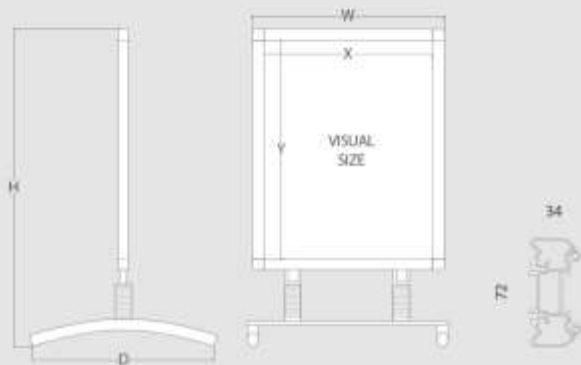

## INFORMATION

Boal Sidewalk is made of aluminum and has a strong base and sturdy springboard design which allows flexion in windy conditions. It has a 34mm width profile with click system, so the graphic change is quick and simple. It includes a resistant antireflection sheet so is also non-glare which allows it to be read under bright lights. Ideal for displaying outside your event, restaurant, street stall or supermarket, for advertising offers or temporary exhibitions.

BOAL	QTY	h (kg)	l (kg)	G.B.M	Size (WxHxD)
Packing	1	7.8kg	9.4kg	0.066	750x1000x80
	1	4.55kg	4.85kg	0.009	140x670x100
		Visual (XxY)	External (WxHxD)		
Product		170x85	640x1130x80		
10.166		Graphic Size: 605x860mm			

## BOAL





# HERVAS



**DIMENSIONS**      ° W: Width    H: Height    D: Depth    ° mm

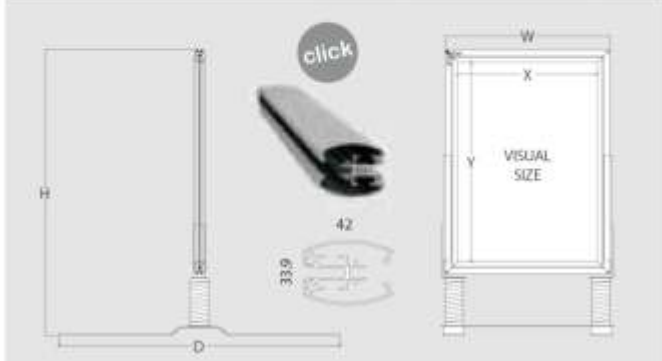

**INFORMATION**

Hervas Sidewalk is made of aluminum and has a strong base with a wide footprint and sturdy springboard design which allows the flexion in windy conditions. It has a 42mm width profile with click system, so the graphic change is quick and simple. It includes a resistant antireflection sheet. Ideal for being used inside or outside your gas station, restaurant, street stall or supermarket for advertising last promotions.

HERVAS H100	QTY	N.W	G.W	C.B.M	Size (WxHxD)
Packing	1	4.3kg	5.0kg	0.0371	965x255x65
	1	9.35kg	9.9kg	0.0043	1010x77x55
		Visual (X-Y)	Extreme (WxHxD)		
Product		465x666	575x856x940		
<b>10.161</b>	<b>Graphic Size: 500x700mm</b>				

HERVAS H1000	QTY	N.W	G.W	C.B.M	Size (WxHxD)
Packing	1	6.75kg	8.45kg	0.0574	116x125x65
	1	9.35kg	9.9kg	0.0043	1010x77x55
		Visual (X-Y)	Extreme (WxHxD)		
Product		665x966	750x1256x940		
<b>10.162</b>	<b>Graphic Size: 700x1000mm</b>				



# SIDEWALK BOARDS



Click Refillable Base

**new**

### SIDEWALK DETAILS

grey or black base

### DIMENSIONS

### PROFILE

42mm

click

### INFORMATION

This waterproof Click Board is designed especially for outdoor use. The heavy-duty, molded plastic base features a screw-in cap and can be filled with 24l of water for 10.341 and 10.115 models and 52l for 10.116 and 10.342. Also it has a 42mm width waterproof profile with click system, so the graphic change is quick and simple (weather resistant antireflection sheet included). Built-in wheels also make this board easy to move as needed. To further enhance its stability Arcachon features rugged springs to reduce the impact of wind. Ideal for displaying outside the restaurants, street stall, events, supermarkets or fuel stations.

## ARCACHON



ARCACHON #500	QTY	N.W.	G.W.	C.B.M.	Size (WxD)
Packing	1 Frame	6.75kg	8.9kg	0.0475	660x600x80
	1 Base	3.3kg	4.4kg	0.068	800x700x50
		Visual (D-Y)	External (WxHxD)		
Product		476x678	542x738x50		
10.115					Graphic Size: 500x700mm

ARCACHON #1	QTY	N.W.	G.W.	C.B.M.	Size (WxD)
Packing	1 Frame	6.1kg	8.3kg	0.066	360x540x80
	1 Base	3.3kg	4.4kg	0.068	800x700x50
		Visual (D-Y)	External (WxHxD)		
Product		572x659	636x732x50		
10.341					Graphic Size: A1

ARCACHON #700	QTY	N.W.	G.W.	C.B.M.	Size (WxD)
Packing	1 Frame	9.1kg	10.9kg	0.0745	810x615x80
	1 Base	5.75kg	6.9kg	0.065	870x810x80
		Visual (D-Y)	External (WxHxD)		
Product		678x716	742x822x70		
10.116					Graphic Size: 700x1000mm

ARCACHON #0	QTY	N.W.	G.W.	C.B.M.	Size (WxD)
Packing	1 Frame	10.25kg	11.6kg	0.1051	960x550x80
	1 Base	5.75kg	6.9kg	0.065	970x870x80
		Visual (D-Y)	External (WxHxD)		
Product		833x882	100x550x100		
10.342					Graphic Size: A0

## ANTIREFLECTION SHEET

**new**

- EN Antireflection protector sheet for snapframes.
- FR Antireflet pour cadres ou chevalets.
- PT Película antirreflexo para marcos e caveletos.
- ES Protector antirreflex para marcos y caballetes.

SHEET	SIZE
13.836	534x734mm
13.837	735x1034mm
13.838	628x875mm
13.839	875x1223mm



# SIDEWALK BOARDS Textil Refillable Base



## MIKONOS

### SIDEWALK DETAILS

double sided



REF. 15.243

REF. 15.242

Printing on fabric.  
Impressão em tecido.  
Impression en tissu.

 TEXTILE

### EXTERNAL SIZES & DOWNLOADABLES ARTWORKS (QR CODE) <sup>mm</sup>

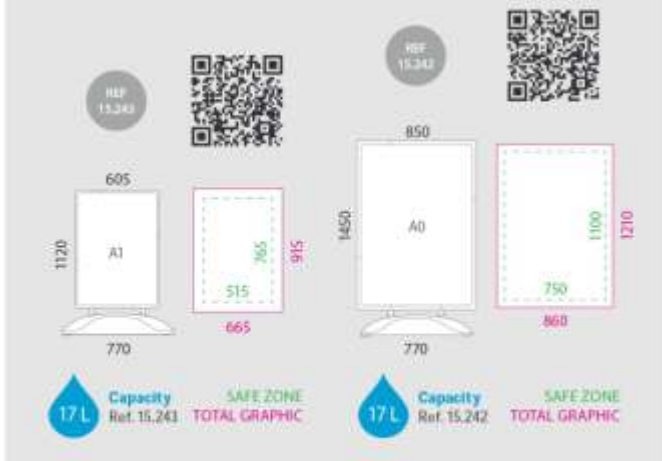

REF. 15.243

REF. 15.242

Capacity 17 L Ref. 15.243

SAFE ZONE TOTAL GRAPHIC

Capacity 17 L Ref. 15.242

SAFE ZONE TOTAL GRAPHIC

### INFORMATION

The Mikonos Sidewalk features a lightweight aluminum structure with a refillable plastic base that assembles in seconds (It is 3.95kg weight and it can be filled with 17l of water or sand). Also, the Textile Boards are also simple to setup. All the aluminium poles fit together and snap into base. Simply stretch the wrap over the completed base and it's ready to use. The aluminium structure is affixed to the base with 2 large springs, so it stays stable in windy conditions. Built-in wheels also make this board easy to move as needed. A Nylon Carrying bag is included for an easy storage and transportation. Ideal for denoting your business with the innovative design and versatility of textil printing. TheSidewalk is ideal for being used inside or outside of your restaurant, workshop, street stall, supermarket or heavily-trafficked areas such as trade shows, events or conventions.

MIKONOS A1	QTY	N.W	G.W	C.B.M	Size (WxHxD)	
Packing	1	7.9kg	9.9kg	0.11	520x440x230	 17L
15.243	Graphic Size:665x915mm					

MIKONOS A0	QTY	N.W	G.W	C.B.M	Size (WxHxD)	
Packing	1	8kg	10kg	0.11	520x440x230	 17L
15.242	Graphic Size:860x1210mm					



\* Custom textil printing in full color is available but not included.

# SIDEWALK BOARDS



Steel Boards

## SIDEWALK DETAILS



## INFORMATION

Kerry 2-sided structure is made of durable lacquered galvanized steel, ensuring years of durability and functionality, available in 3 colors. Designed for indoor and outdoor use. The non-glare protective cover (included) attaches easily using magnets. Ideal to advertise home sales, open houses, restaurant specials, or store sales.

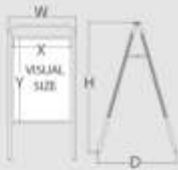

KERRY 1000	QTY	N.W	G.W	C.B.M	Size (WxHxD)
Packing	1	11.9kg	12.7kg	0.0504	535x647x100
		Visual (X-Y)	External (WxHxD)		
Product		462x662	544x1056x147		
10.691		<input type="radio"/> <input type="radio"/> <input type="radio"/>	Graphic Size: 500x700mm		

KERRY 1000	QTY	N.W	G.W	C.B.M	Size (WxHxD)
Packing	1	16.25kg	17.1kg	0.0766	760x704x140
		Visual (X-Y)	External (WxHxD)		
Product		662x962	744x1345x184		
10.692		<input type="radio"/> <input type="radio"/> <input type="radio"/>	Graphic Size: 700x1000mm		

## KERRY



## SIDEWALK DETAILS



## INFORMATION

Cork 2-sided structure is made of durable lacquered galvanized steel available in 3 colors. Designed for indoor and outdoor use. Also it features a top header area. The non-glare protective cover (included) attaches easily using magnets. Ideal to advertise home sales, open houses, restaurant menu specials or store sales.

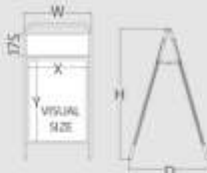

CORK 1000	QTY	N.W	G.W	C.B.M	Size (WxHxD)
Packing	1	11.9kg	12.7kg	0.0498	460x640x100
		Visual (X-Y)	External (WxHxD)		
Product		462x662	544x1056x147		
10.695		<input type="radio"/> <input type="radio"/> <input type="radio"/>	Graphic Size: 500x700mm Top Header Gr. Size: 175x504mm		

CORK 1000	QTY	N.W	G.W	C.B.M	Size (WxHxD)
Packing	1	16.65kg	17.3kg	0.0766	760x704x140
		Visual (X-Y)	External (WxHxD)		
Product		662x962	744x1345x184		
10.696		<input type="radio"/> <input type="radio"/> <input type="radio"/>	Graphic Size: 700x1000mm Top Header Gr. Size: 175x704mm		

## CORK



# SIDEWALK BOARDS Steel Boards



## MONAGHAN

### SIDEWALK DETAILS



### INFORMATION

Monaghan 2-sided board is made of durable lacquered galvanized steel available in 3 colors. Designed for indoor and outdoor use. With a top header for a graphic and a non-glare protective cover. Ideal to advertise home sales, open houses, restaurant menu specials or store sales.

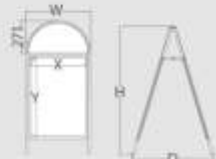

MON	QTY	N.W	G.W	C.B.M	Size (WxHxD)
Packing	1	11.7kg	12.7kg	0.0459	560x700x110
		Visual (X-Y)	Visual Top (X-Y)		External (WxHxD)
Product		462x682	502x250		483x1078x881
10.699	<input type="checkbox"/>	<input type="checkbox"/>	<input type="checkbox"/>	Graphic Size: 500x700mm Top Header Gr. Size: 514x256mm	

MON	QTY	N.W	G.W	C.B.M	Size (WxHxD)
Packing	1	7.5kg	8.5kg	0.0302	700x1000x50
		Visual (X-Y)	Visual Top (X-Y)		External (WxHxD)
Product		702x1002	702x261		742x1523x675
10.700	<input type="checkbox"/>	<input type="checkbox"/>	<input type="checkbox"/>	Graphic Size: 700x1000mm Top Header Gr. Size: 714x357mm	



### SIDEWALK DETAILS



### DIMENSIONS - LIFFORD JOINING USE

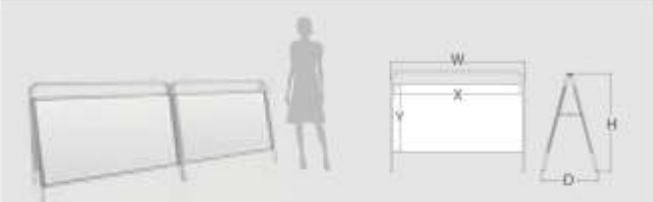

### INFORMATION

Lifford 2-sided board is made of durable white lacquered galvanized steel. Designed for both indoor and outdoor. With non-glare protective cover included which attaches easily to the front using magnets. Ideal to use together with other(s) Lifford for creating a large billboard (see upper example).

LIFFORD	QTY	N.W	G.W	C.B.M	Size (WxHxD)
Packing	1	15.7kg	17kg	0.0751	938x650x235
		Visual (X-Y)	External (WxHxD)		
Product		1026x684	1200x672x605		
10.701	<input type="checkbox"/>	Graphic Size: 1156x600mm			

## LIFFORD



\* 10.701 Lifford Board of this page is sold by units, the image represented is just one example of its joint use.

# SIDEWALK BOARDS A-Board

## SIDEWALK DETAILS



## DIMENSIONS

\*mm



## INFORMATION

The Steel A-board is made of durable Epoxi painted Steel. Featuring 6 colors available and the possibility of being used with a white board panel which is sold separately (10.168). Ideal to advertise home sales, open houses, restaurant specials, store sales or promotional services. To change out signs, just slide the poster through the steel holders.

STEEL A-BOARD	QTY	N.W	G.W	C.B.M	Size (WxHxD)
Packing	1	8kg	8.3kg	0.0521	1200x650x670
		Visual (X-Y)			External (WxHxD)
Product		600x1000			650x750x700
10.167					
WHITEBOARD P	QTY	N.W	G.W	C.B.M	Size (WxHxD)
Packing	1	1kg	1kg	0.0521	1200x650x670
10.168	<input type="checkbox"/>				Total Size: 600x1000mm

## STEEL A-BOARD



# SIDEWALK BOARDS A-Board

## SIDEWALK DETAILS



### INFORMATION

\* W: Width H: Height D: Depth \* mm

The double-sided Dover A-Board features 3 different models, the first one comes with handle for an easy transportation, second one features all along customizable front for a great visual impact and the third model features a Blackboard in front of both sides.



DOVER	QTY	N.W	G.W	C.B.M	Size (WxHxD)
Packing	1	1.0kg	3kg	0.0258	525x540x86
		Visual (X,Y) 33,09	Visual (X,Y) 33,00 33,03		External (WxHxD)
Product	480x715		480x815		500x820x665
13.129		Graphic Size: 480x715mm			
13.130		Graphic Size: 480x815mm			
13.131		Blackboard: 480x815mm			

## DOVER



## STAND DETAILS





### INFORMATION

### DIMENSIONS

\* mm

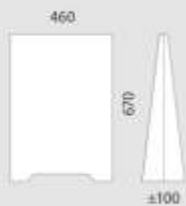
The Neiva stand A-Board has a white finish so it is ideal for customizing with your own offers or graphics. Inexpensive, durable and lightweight, making it easy to relocate as often as needed and also and it's assembled in seconds. Neiva is perfect as Eye-catching advertisement for products promotion at point of sale, malls, retail stores, shopping markets.



NEIVA	QTY	N.W	G.W	C.B.M	Size (WxHxD)
Packing	2	1.74kg	2.74kg	0.0569	1066x980x157mm
13.748		460x100x670mm			x2 

## NEIVA





# SIDEWALK BOARDS Frame Base

## ALUMINIUM BOARD FRAME BASE

### SIDEWALK DETAILS



### DIMENSIONS

### ARTWORK <sup>1</sup>mm



VISUAL ZONE  
TOTAL GRAPHIC



### INFORMATION

Aluminium Board Display is lacquered in gray RAL 9006 and features an easy to load and upload system. With adjustable stability sturdy feet and an easy glide for the 700mm height graphic poster (9mm max.thickness) into the metal grooves of the structure and display it back-to-back. Ideal for promoting at trade shows, outside your office or showroom.

A BOARD D	QTY	N.W	G.W	C.B.M	SIZE
Packing	1	1.29kg	4.40kg	0.0436	880x660x75mm
13.598		Graphic Size: 500x700mm			



# SIDEWALK BOARDS A-Board

## SIDEWALK DETAILS



### DIMENSIONS

### ARTWORK <sup>mm</sup>



VISUAL ZONE: 550x700mm  
TOTAL GRAPHIC: 550x748mm

### INFORMATION

This sidewalk double-sided board is built with long-lasting plastic to resist rust and other weather-related damage. Able to fit 550x748mm posters (5mm maximum thick). Fast and simple change-of-graphic thanks its top insert slots. Delta is lightweight and it folds down quickly for carrying and an easy storage. The non-slip feet keep them steady on both pavement and bumpy grass. It is perfect for any high-traffic area.

DELTA	QTY	N.W	G.W	C.B.M	SIZE
Packing	1	3kg	2kg	0.05	630x80x100/mm
10.679	Graphic Size: 550x748mm				

## DELTA



# SIDEWALK BOARDS Refillable Base Banner

## SIDEWALK DETAILS

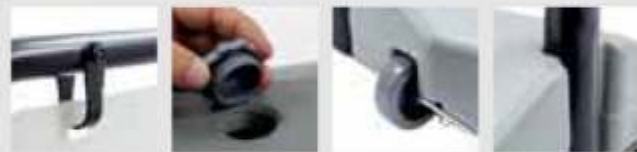

## OCEAN



## TRANSPORT INSTRUCTIONS



- 1 First, use the foot to tilt the board slightly toward to you.
- 2 Then, move the Ocean Display behind you using its wheels.

## INFORMATION

Resting on a plastic 10L water-refillable base, Ocean outdoor unit is designed for indoor and outdoor use. With an oscillating 620x1000mm board, the advertising options are numerous for your business outdoor sign. Each board is double-sided for twice the promotion. When you need to move the unit, the built-in wheels let you easily reposition to a better location or bring it inside at the end of the work day.

## DIMENSIONS <sup>mm</sup>



OCEAN	QTY	N.W	G.W	C.B.M	SIZE
Packing	1	5.4kg	7.0kg	0.17	1000x640x1000mm

10.305      Graphic Size: 500x750mm

